

University of Colorado Law School

Colorado Law Scholarly Commons

Amicus

Spring 2015

Amicus (Spring 2015)

University of Colorado Law School

Follow this and additional works at: <https://scholar.law.colorado.edu/amicus>



Part of the [Law Commons](#)

Recommended Citation

University of Colorado Law School, "Amicus (Spring 2015)" (2015). *Amicus*. 24.
<https://scholar.law.colorado.edu/amicus/24>

This Book is brought to you for free and open access by Colorado Law Scholarly Commons. It has been accepted for inclusion in Amicus by an authorized administrator of Colorado Law Scholarly Commons. For more information, please contact rebecca.ciota@colorado.edu.

AMICUS

University of Colorado Law School

Spring 2015



Our Community



BACK ROW, LEFT TO RIGHT: **Austin Gaddis** ('16), Committee for Inclusiveness and Diversity; **Hunter Metcalf** ('16), Christian Legal Society; **Brandon J. Archuleta** ('16), Latino Law Students Association (LLSA)

FRONT ROW, LEFT TO RIGHT: **Abigail Wallach** ('16), Jewish Law Students Association (JLSA); **Ann Stanton** ('16), OUTLaw; **Jenny Knight** ('16), Women's Law Caucus

AMICUS

VOLUME XXXI, NUMBER 1, SPRING 2015
OUR COMMUNITY



Dean's Letter	2
Community	4
Students	8
Centers	12
News	14
Development	21
Loyal Donors	22
Alumni	23

Electronic copies available at colorado.edu/law/alumni.

Inquiries regarding content contained herein may be addressed to Colorado Law, Attn: Amicus, 401 UCB, Boulder, CO 80309 or to lawalum@colorado.edu.

Editor-in-chief: Keri Ungemah.

Editing: Al Canner and Keri Ungemah.

Writing: Alexandra Berger, Nathan Davis, Mark Fogg, Marci Fulton, Gregory M. Garcia, Sean Keefe, Justice Alex J. Martinez, Joanna Schmitz, Mary Beth Searles, Marcia Segall, Phil Weiser, Julie Ann Williams, and Keri Ungemah.

Design and production: Saffron Park Studio.

Photography: Glenn Asakawa, Hannah Bracamonte, Casey A. Cass, Patrick Campbell, Nicola Leigh Huffstickler, Sarah Krakoff, and Keri Ungemah.

Printing: One Touch Point.

COVER, LEFT TO RIGHT: The class of 2015 board officers:

Jonathan Milgrom, President; **Aditi Kulkarni**, Treasurer;
Cayla Crisp, Secretary; and **Vikrama Chandrashekar**, Vice President.



A TRADITION OF COMMUNITY

Dean Phil Weiser

This issue of the *Amicus* focuses on our diverse, inclusive, and engaged community. Since I joined the faculty, I have appreciated that our small size, commitment to working together, and diversity of backgrounds enrich our faculty, staff, and students in a range of ways. Notably, the friendships and collaborations we enjoy at Colorado Law make us stronger, more welcoming, and more stimulating. In short, we have a special community and it is incumbent on us to keep it that way.

The concept of “diversity and inclusiveness” underscores that merely having diverse people and opinions around is not sufficient; the overarching goal must be to embrace diversity as part of our overall culture, ensuring that everyone feels included and heard. This goal is hard to meet. In furtherance of achieving that goal, the range of diverse student groups, the variety of our students’ backgrounds, and the extent of our community connections are all starting places for our commitment to remaining, as our Action Plan puts it, “an engaged, diverse, and inclusive community of outstanding students, faculty, staff, alumni, and friends who help and support one another as well as serve our communities.”

Our world is an increasingly interconnected and global environment. To thrive in such a world, students must be prepared to interact with and appreciate the identities of those different from themselves. This vision of appreciating diverse identities has become the norm in several sectors from which we seek to learn. In the business world, for example, the value of diversity is increasingly appreciated. As James Surowiecki

“ DEAN PHIL WEISER

The friendships and collaborations we enjoy at Colorado Law make us stronger, more welcoming, and more stimulating.”

recently wrote in *The New Yorker*, “a large body of evidence suggests that making organizations more diverse can also make them perform better,” noting further that “organizations with the most diverse executive teams had dramatically higher returns on equity and earnings performance than those with the least diverse teams.” Colorado Law’s commitment to diversity and inclusiveness means that we seek to prepare students for a world where globalization is a fact and working in diverse teams is the norm.

Being a member of the legal profession is a privilege that bears great responsibility. Lawyers and the law have fostered civil rights in our

nation and beyond. This history reminds us of the unique ability of law to promote true diversity and inclusiveness in society. In powerful reminders of this history and in efforts to expose students to diverse viewpoints, we recently hosted lectures by U.S. Supreme Court Justices Ginsburg, O’Connor, and Scalia. In their talks, Justices Ginsburg and O’Connor spoke about their own personal stories of overcoming sexism in the legal profession and the work that remains to be done.



While at Colorado Law, our students have an opportunity to work with and assist a wide range of members of the broader community who are in need of legal services, such as children, entrepreneurs, immigrants, Native communities, veterans, and those from other countries at risk of deportation. Through such opportunities, Colorado Law works to develop a greater sense of empathy, which is essential for all successful, ethical legal professionals.

In focusing on diversity, inclusiveness, and collaboration in this issue of *Amicus*, I recognize that constant vigilance is required in these areas. While America has strived to be “the land of the free,” our nation’s history is rife with injustices that include discrimination along racial, ethnic, religious, sexual orientation, and gender lines that we must continue to work to overcome. Some students today may not even realize that just two generations ago, segregation was in full effect and “separate was still equal” in schooling, Japanese-Americans were in internment camps, Jews and homosexuals were in concentration camps, the sovereignty of Native Americans was under assault, and women were effectively shut out of the legal profession.

Over the last two generations, we have made great strides in moving toward providing all citizens “equal protection under the law.” But as Justice O’Connor wrote in the *Grutter* decision and reminded us during her visit, this vision remains a work-in-progress. As we work to strengthen our diverse and inclusive community—with our faculty, staff, students, alums, and community members all playing an important part—we are not only preparing our students for today’s world, but also joining in the project of working toward equal opportunity for all.

IN THE NUMBERS

CLASS OF 2017 (AS OF 8/25/2014)

2180

Applications

168

Class size

161

LSAT score (median)

3.62

Cumulative GPA (median)

18%

Diverse students

105

Undergraduate colleges

38

States

46%

Women

LAW SCHOOL

9.2:1

Student-to-faculty ratio at Colorado Law

69%

Classes smaller than 25 students

Top 20

Colorado Law's rank in practical legal education (2015), *The National Jurist*

EMPLOYMENT

98.5%

Colorado Law students working in substantive legal summer jobs in 2014

1

The mountain region's rank as the best legal job market for entry-level graduates (2015), *The National Jurist*

24

Colorado Law's rank in the nation for class of 2013 graduates employed in any JD-required or JD-advantage positions, *Moody's*

LOCATIONS VISITED (SINCE JULY 2011)

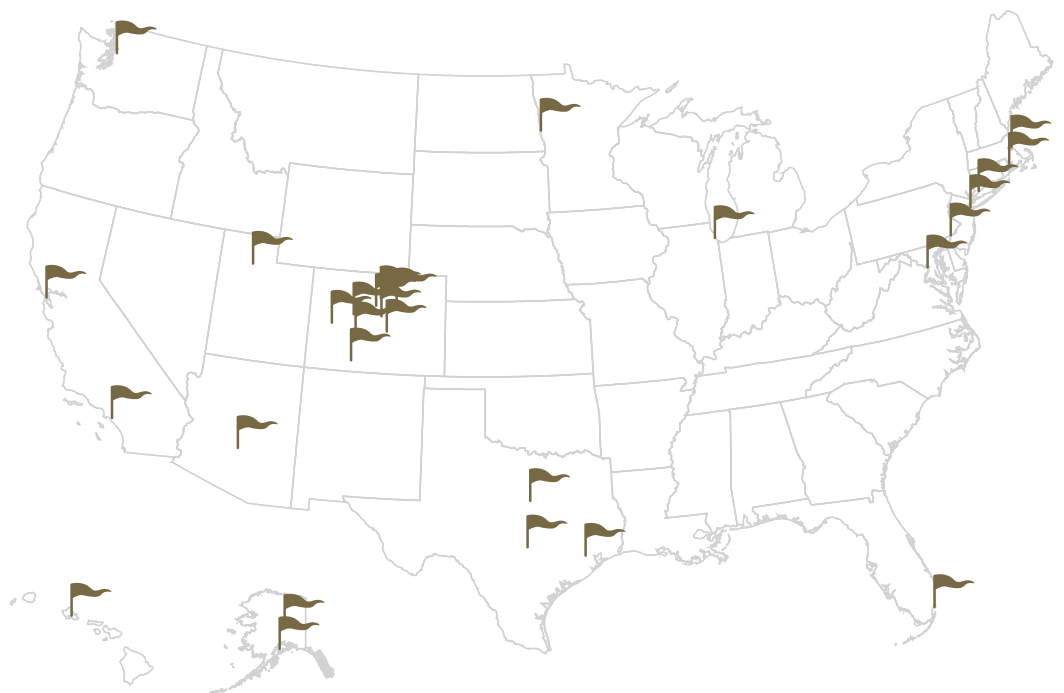

COLORADO LAW'S CULTURE

By Sean Keefe ('17)

When Justice Antonin Scalia stood behind a podium to address more than 1,400 people at the fourth annual John Paul Stevens Lecture of the **Byron R. White Center for the Study of American Constitutional Law** in October 2014, there was an audible buzz and palpable tension. Justice Scalia is the longest-tenured U.S. Supreme Court Justice and is famous for his scathing dissents and his ardent advocacy for originalism in interpreting the U.S. Constitution. In his talk, Justice Scalia challenged the audience to think critically and examine the unintended consequences of a “living Constitution.” It was exactly the hour that Federalist Society President **Mike Havlik** ('15) had in mind. Having Justice Scalia on campus generated exactly the kind of robust intellectual debate that makes Colorado Law's community special. “It is critical for students to wrestle with difficult issues,” said Havlik. “We work hard to create great opportunities for debate.”

Justice Scalia's talk is one of many ways that students at Colorado Law confront different perspectives, backgrounds, and viewpoints. The call to think critically and to embrace diversity of thought and background began at orientation with a panel discussion on “Fostering an Inclusive Community,” led by incoming Law Alumni Board Chair **Franz Hardy** ('00). During that panel, Hardy and others encouraged students to learn from differences, realize the world is at times often very gray, and that, as former Colorado Governor **Roy Romer** ('52) often put it, “all truth is partial.”

“**FRANZ HARDY** ('00)

Every day of your legal career you are going to encounter a client, colleague, judge, or opposing counsel who is different than you are, but the key is to learn how to get along, how to build coalitions, and how to accept each other and move forward.”

Hardy ardently believes that inclusion enriches the Colorado Law community. “Inclusion is an issue that affects everyone and we are all limiting ourselves when we do not have difficult conversations on complex issues. We owe it to each other to tear down these walls and learn from one another,” said Hardy. “It is the ultimate goal of inclusion.”



Melissa Hart, professor and director of the Byron White Center, and U.S. Supreme Court Justice Antonin Scalia.

Denver City Attorney **Scott Martinez** believes that to continue breaking down barriers there needs to be a more robust understanding of the meanings of the terms diversity and inclusivity. “Embracing diversity means understanding the count of various people in your office or organization,” said Martinez. “Embracing inclusivity means making sure everyone in your office or organization counts.” From the start of orientation until graduation, the Colorado Law faculty and staff all live by the mantra that every student matters.

Adherence to this mantra requires people to think more broadly and to break down barriers to inclusivity. “Diversity isn't just about a few people over there; diversity applies to every one of us,” said Colorado Law Senior Director of Diversity and Inclusive Excellence **SuSaNi Harris**. The dimensions of diversity go beyond race, gender, and sexual orientation, and often elude simple descriptions.

Jonathan Julio Jourdane ('15), for example, is a third-year student who grew up in San Diego with a Panamanian mother and an American father. For Jourdane, inclusivity is part of his upbringing; as he put it, “regardless of where you came from or what you look like, that does not define who you are or what you bring to this community.” And when the floods recently broke down physical barriers in Boulder, Jourdane catalyzed efforts that brought Colorado Law's entire community together in helping all who needed support.

Kevin Brown ('13), a U.S. Marine Corps attorney, believes our perspectives shape who we are. “When you are looking at peoples' experiences, not skin colors or men versus women,” said Brown, “it gives you a frame of reference to allow us to truly learn from each other.”

FACING PHOTO, LEFT TO RIGHT: **Mike Havlik** ('15), Federalist Society president; **G Matthews** ('16), Black Law Students Association president; and **Jenny Knight** ('16), Women's Law Caucus president.



Unlike many of his peers who had just finished their undergraduate education, Brown's life perspectives have been shaped by three combat deployments as an attack helicopter pilot in the U.S. Marine Corps. During his decade of service, Brown became accustomed to the structured military lifestyle but began to thirst to be around different people and more diversity of thought.

"I am so appreciative of the time I had in Boulder," said Brown. "With the culture of respect at the school so engrained, I never encountered a negative or hostile comment, even with so many people with differing opinions than my own."

Professor and Director of the White Center **Melissa Hart** believes the community of respect is fostered not only by the faculty, but also by the growing emphasis in the admissions process on finding students with unique backgrounds, a spirit of intellectual curiosity,

how to both interview them and subsequently advise them of the potential immigration consequences of any disposition in their criminal case. "Lawyers who work with vulnerable and marginalized populations must commit early to a standard of zealous representation for all of their clients, regardless of their ability to pay for that representation," says Chapin.

U.S. District Court Judge **Christine Arguello** explained how the Colorado Law experience is a very different one than what she went through. "When I was in law school, the thinking was very insular; you were taught to think like a lawyer," said Arguello, "not how to be an effective lawyer." A crucial trait of effective lawyers, and a theme emphasized at Colorado Law, is the ability to communicate and empathize with clients.

Drawing from her expertise as a professional mediator

“ JENNY KNIGHT ('16)

Since coming to Colorado, I have felt like more than just a face in the crowd. It is really easy to strike up conversations with amazing women who want to reach out and help you succeed."

and a growth mindset. As **Dean Phil Weiser** explained, "we are committed to recruiting students interested in challenging assumptions, asking hard questions, and learning from experience."

For Brown, the experience at Colorado Law was a welcomed breath of fresh air. "I can honestly say every single day of law school was the best day of my life because I felt so fortunate to have the opportunity." Dean Weiser encourages students to embrace the opportunity of finding their own path, remarking that Kevin Brown set a tremendous example of reaching out to a range of community members and taking the opportunity to learn from all of them.

Associate Clinical Professor **Violeta Chapin**, who teaches Colorado Law's Criminal and Immigration Law Clinic, works with a range of students who represent poor people who have been charged with misdemeanor offenses in Boulder County. If clients are not citizens of the United States, students learn

and conflict resolution scholar, Associate Professor **Anna Spain** believes promoting institutional diversity and inclusiveness requires "understanding the complexities of individual identities alongside the structural and historical inequalities that are still a part of American society." She believes that "an institution committed to inclusiveness must also be committed to acknowledging discrimination where it exists, as it often prevents diverse people from being included." In her mediation classes, Spain teaches her students techniques to treat all people with dignity, to master one's own self-awareness of bias, and to develop the capacity for deep empathy.

During his summer job working in Durango, Jonathan Jourdane took this theme seriously and measured his success by how effectively he was able to communicate with his clients. Working with many Native Americans, Jourdane had to learn from his clients how best to serve their legal needs. "It starts with the understanding that not everyone is



Jonathan Julio Jourdane ('15)



Kevin Brown ('13)



Violeta Chapin



Anna Spain



Franz Hardy ('00)

the same. My core values may be different from the family I am working with, but I need to be able to understand and appreciate their perspective and find a way to serve them best," said Jourdane.

Michelle Lucero ('89), general counsel for Children's Hospital Colorado, echoes the need for cultural change. Lucero interacts daily with clients whose backgrounds and experiences represent all types of diversity in Colorado. Her success depends on her ability to connect with her clients and identify their needs. "If you do not come to work with an inclusive mindset, you will not be successful personally, or for your client," said Lucero. "It is a must have."



Michelle Lucero ('89)

Hart notes that the key to success in creating an inclusive community is for each of us to "be self-aware about the assumptions we make." We are going to step on people's toes throughout our lives. It would be hard not to," said Hart. "The key is to be aware and constantly challenge yourself on how to improve further." Throughout his 14-year legal career, Franz Hardy has come across diversity every day. "If you are going to survive, you must learn how to get along with others," explains Hardy. "Every day of your legal career you are going to encounter a client, colleague, judge, or opposing counsel who is different than you are, but the key is to learn how to get along, how to build coalitions, and how to accept each other and move forward," said Hardy.



Judge Gary Jackson ('70)

G Matthews ('16), president of the Black Law Students Association, believes collaboration begins with a willingness to allow others to have a voice. "When you treat other people's experience as co-equal to your own, it allows you to become more flexible in your own beliefs," said Matthews. Having a flexible mindset has allowed Matthews to make deeper connections with fellow students and future clients. "The world isn't perfect. There are no black and white answers, and you have to have a willingness to listen to each other," said Matthews.



Jenny Knight ('16)

Even with the awareness and increasing emphasis on inclusivity, traditionally underrepresented groups face challenges in the legal field. Despite making up approximately 33 percent of the U.S. population, only 11 percent of lawyers are racial or ethnic minorities. The percentage of lawyers who are from traditionally underrepresented groups plummets to four percent of partners in private law firm practice.

There are, however, encouraging signs of progress, noted Judge **Gary Jackson** ('70), who sits on the diverse and inclusive bench of the Denver County

Court, which includes 17 judges, half of whom are women and a majority of whom are from traditionally underrepresented minorities. "I am proud to say I serve on one of the most ethnically and culturally diverse benches in the state," said Judge Jackson. "It lends respect for the legal system when judges reflect how their greater community looks."

The commitment to inclusiveness and collaboration in the Colorado legal community and at Colorado Law make a real difference for students and alumni. **Jenny Knight** ('16), president of the Women's Law Caucus, has established a range of community connections among women attorneys and current law students. Being in a small, tightly connected legal community makes it easy for students to connect with alumni for coffee and mentoring. "Since coming to Colorado, I have felt like more than just a face in the crowd. It is really easy to strike up conversations with amazing women who want to reach out and help you succeed," said Knight.

Judge Arguello also shares the belief that Colorado's tight-knit legal community is an accepting and open one. "This is a community where outsiders are welcomed with open arms," said Judge Arguello. "Denver is a big city with a small-town mindset. When you see the same colleagues time and time again, if you can't get along and work openly and collaboratively, you won't get very far here or anywhere," said Judge Arguello. In other words, to succeed here, it is best to follow the example of many in our community and have open arms and an inclusive mindset.

For Dean Weiser, the close connections among Colorado Law alumni, despite their widely ranging backgrounds and experiences, go well beyond the state of Colorado. "Wherever I travel, I've found that the Colorado mindset—of inclusion and collaboration—is something our alumni hold on to," Weiser explained. "The deep interest in learning from and helping one another is what makes Colorado Law special."

STUDENTS FILL NEED FOR LEGAL RESOURCES

By Sean Keefe ('17)

It is a long drive, approximately five hours, following the mountains south, through Denver, and beyond the reaches of the sprawling Front Range suburbs. **Blake Busse** ('15), a third-year student at Colorado Law, has taken the 200-mile trek countless times. Busse and approximately 25 other law students made the trip to the San Luis Valley for the first time in April 2013 as part of the newly formed Colorado Acequia Assistance Project.

"I remember receiving an email about the project from Professor Krakoff in January after my first semester, and I knew it was for me," said Busse. "I was interested in water rights, and this was an area of my home state that I didn't know much about."

Acequias, explained Professor **Sarah Krakoff**, are simple irrigation systems used by rural farmers throughout the Valley, in an area including four of the poorest counties of Colorado. Many of these farmers' families have used acequias to irrigate and tend the land for centuries. However, they face numerous legal challenges in a region where water is sparse and legal resources even sparser.

For years, many San Luis Valley irrigators operated acequias informally, without incorporation or bylaws, and sometimes without formal recognition of their water rights. This can create problems today, because state officials may question diversions that lack a formal decree. "Prior appropriation means 'first in time, first in right,'" said Krakoff. "But how can you prove that when their rights haven't been properly documented or written down?"

That is where the Acequia Assistance Project stepped in, back in the summer of 2012. Krakoff, in conjunction with the **Getches-Wilkinson Center for Natural Resources, Energy, and the Environment**, Colorado Open Lands, and the Sangre de Cristo Acequia Association, aimed to provide low- or no-cost legal assistance and educational materials to Colorado's acequia communities.

For Busse, it was the first time he sat across the table from a client. He had to learn different clients' needs and build trust to best serve those needs. "The project has been significant for me because it added an important human component into my studies. Working with my clients taught me how to apply legal doctrine to solve real problems," said Busse.

In addition to the legal legwork, Busse said students get their hands dirty during clean-up days in the ditches. In addition to its literal meaning, the term acequia reflects the philosophy of sharing and community. Busse has worked with the same clients for three years and established a lasting connection. As the next generation of the Acequia Project begins to take over, Busse hopes to have completed his final close-out letter. He submitted his client's appropriation application on December 31, 2013, and hopes to hear a final confirmation before graduation.

"It has been a lot of work, but it has been extremely rewarding work. I'll look back on my days in the Valley as the best in law school," said Busse.



LEFT TO RIGHT: **Will Davidson** ('15), **Blake Busse** ('15), **Will Hauptman** ('17), and **Nick Mahoy** ('17).

“ **BLAKE BUSSE** ('15)

The project has been significant for me because it added an important human component into my studies. Working with my clients taught me how to apply legal doctrine to solve real problems.”

REDUCING HEALTH DISPARITIES

Alumni, Students, and Faculty Join Forces to Help Those in Need



Dayna Matthew

In February 2013, one request stood out from the many on the desk of Alfonso Silva, then-CEO of a property management company in charge of more than 2,500 units in the Denver Metro area. Neither the letterhead nor the signature of **Siddhartha Rathod** ('07), a partner in a successful downtown Denver firm, caused this housing request to give Silva pause, nor the fact that the letter found Silva by way of Denver City Councilman Paul Lopez. What caught Silva's attention was the story therein about a nine-month-old boy named Kevin Gallegos-Gonzalez. Said Silva, "That little boy, he is an angel. I knew we had to help."

For the first seven months of his life, Kevin could not live at home with his loving mother and father, Maria Gonzalez-Albarado and Francisco Gallegos-Villanueva. He was born with laryngeal stenosis, a congenital disease that causes an abnormal narrowing of the main airways. When the doctors at Children's Hospital discovered this life-threatening condition, they needed to perform surgery to open up the constricted airway. After many successful surgeries, Kevin was able to breathe with a tracheal tube and finally permitted to join his family at home.

Home for the Gallegos-Gonzalez family was a small apartment with one bedroom, one bathroom, a small kitchen, and a small living room. The apartment quickly became overwhelmed by Kevin's medical equipment. The living room, where his crib stood, became a labyrinth of tubes and wires. Further compounding the troubles, the cramped apartment was on the second floor of the complex, complicating efforts to give Kevin time outside. The Gallegos-Gonzalez family needed a miracle. Little did they know, Silva would provide just that.

In order to connect the Gallegos-Gonzalez family with its miracle, a team of passionate individuals worked hard to help. Rathod, Colorado Law Professor **Dayna Matthew**, her law students **Karin Ross** ('15) and **Eden Rolland** ('15), and Nichole Tuitt, a master's candidate in the School of Public Health, volunteer their time as part of the **Colorado Health Equity Project (CHEP)**. CHEP is a collaboration of students, faculty, public interest groups, pro bono attorneys, public health advocates, and physicians dedicated to improving health outcomes for vulnerable populations to reduce health disparities and inequity in Colorado. For Matthew, CHEP fills an important niche while taking an interdisciplinary approach to solving legal and medical issues. Often times, there are many poor and underserved families who do not have the access to services or opportunity to address their legal needs. "It is important to realize that the law on the books does not equal the law on the street," said Matthew.

This was the case for the Gallegos-Gonzalez family. As Kevin continued to grow into a toddler, it was apparent the family's living situation was going to be inadequate. Compounding the constraints of the apartment, the landlord was trying to evict the family. Rathod and the rest of the CHEP team stepped in, and with the help of student attorneys Ross and Rolland, CHEP halted the eviction process, recovered the family's full security deposit, and sought a better home.

Through CHEP's community connections and the hands-on work by the law students, a letter made its way onto Silva's desk, requesting housing and rent assistance. "Alfonso is a saint," said Rathod. "He had no requirement to help, but saw the family and was compelled to do something." Within three weeks of Silva's receipt of the letter, a moving truck arrived at a two-bedroom, ground-level apartment in Aurora. Out stepped Rathod, with volunteers from his firm and CHEP, ready to assist the family by moving furniture and equipment into their new home. "It was a great day. I've been blessed to be able to help this family and get the opportunity to continue watching Kevin grow," said Rathod.

“ ” DAYNA MATTHEW

It is important to realize that the law on the books does not equal the law on the street.”

TECH LAWYER ACCELERATOR

By Sean Keefe ('17)

Last year, the **Silicon Flatirons Center for Law, Technology, and Entrepreneurship** launched its acclaimed Tech Lawyer Accelerator program, helping students secure jobs working with start-ups and technology firms. The program matches selected first- and second-year law students with local and national technology firms for 10-week summer internships after four weeks of intensive business and technology training.

Going into its second year, the program garnered several mentions from *The New York Times* as a leader in alternative approaches to the typical

“ SIERRA MOLLER ('16)

I got the opportunity to do work that I thought I wouldn't be able to do until I was at least a third-year associate.”

Socratic legal education. Applications to the program have dramatically increased and so has outside company interest. **Bill Mooz** ('85), the scholar in residence who established the program, said that 100 percent of the invitations extended to last year's companies to return have been accepted, and he hopes to bring new companies on board this year.

In the first year of the program, students worked with companies in Boulder and Denver, as well as in the San Francisco Bay Area. Each student experienced unique, real-world challenges by serving as in-house counsel. **Karl Hoffman** ('15), a third-year student, developed an interest in securities while interning at the U.S. Securities and Exchange Commission in Denver. Hoffman wanted to find an internship for his second-year summer that was focused on securities in a corporate setting. After interviewing, he was placed with Broomfield-based Zayo Group.

During his time at Zayo, Hoffman worked as part of a sizeable in-house team and reported directly to the general counsel. He focused primarily on the initial public offering for the telecom company, which raised \$287 million. Hoffman applied his experience interning at the SEC to perform due diligence research to assist management, outside counsel, and underwriters in preparation for the filing of a Form S-1 with the SEC. “The program is truly innovative in the legal education landscape. I was able to prepare for my employment by learning the business fundamentals that they don't teach you in a typical law school class,” said Hoffman.

Hoffman was faced with unique challenges during his 10 weeks at Zayo, but he was hardly alone. **Sierra Moller** ('16), a second-year student, spent her summer working as in-house counsel at Market Force, a start-up that provides customer intelligence solutions to multi-location businesses. On Moller's third day on the job, the company embarked

on a restructuring. The majority of the executive leadership team was removed and Moller began to work with the general counsel on the corporate reorganization. “I got the opportunity to do work that I thought I wouldn't be able to do until I was at least a third-year associate,” said Moller. “I covered so much in such a short time—restructuring is very common for start-ups. It was a stressful time, but the experience was incredible.”

There is also an extended Tech Lawyer Accelerator program that places students with companies for seven-month internships instead of the 10-week summer program. For Mooz, the seven-month program is all about the value proposition for the student. Accepted students can use the established Colorado Law opportunity to graduate in 2.5 years and can use the fall semester of their third year to work with the company.

Whitney Carlson ('15) is part of the seven-month internship program at Cisco in San Jose, California. Carlson sees the program as an opportunity to differentiate herself from the crowd in the job market. Carlson, a native Californian, would like to work in California after graduating. Working at Cisco has allowed her to expand her networks in the Bay Area. She has been in contact with many Colorado Law alumni who are excited about the growing pipeline between the school and Silicon Valley. “My work at Cisco has all been substantive,” said Carlson. “Our general counsel, Mark Chandler, really believes in the program. He believes in training lawyers, not just teaching them legal doctrine. At Cisco, they really want the students to succeed, and want to make sure that we are ready for practice when we graduate.”

For Mooz, that is what the program has been all about. “Colorado Law is helping open new doors for students,” said Mooz. “Students learn real skills to prepare them to go in-house from day one, an opportunity that many students previously did not have.”



LEFT TO RIGHT: **Sierra Moller** ('16), **Karl Hoffman** ('15), and **Whitney Carlson** ('15).

NEW ONE-YEAR DEGREE IN PATENT LAW

By Gregory M. Garcia ('16)

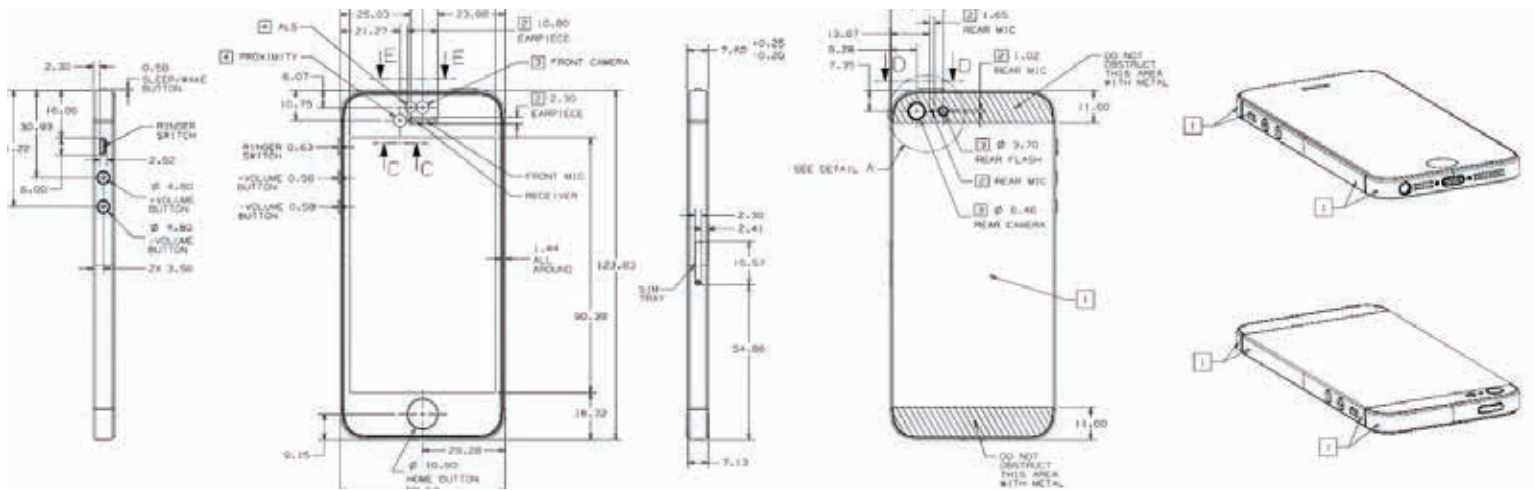

Patent drawing for Apple Inc.'s iPhone 5.

The way clients access legal services is changing in many ways. In today's world, there is a range of opportunities for professionals with legal training short of a JD to take on important responsibilities—from serving as patent agents to being contract managers to working as compliance officers. Many large companies increasingly direct legal work to these professionals. Recognizing this emerging state of affairs, and seeking to train a new generation of professionals, Colorado Law is launching a Master of Studies in Law (MSL) program in the fall of 2015. “The demand for people with legal backgrounds is strong, but shifting,” explains Associate Professor **Erik Gerding**, director of the new program. “The MSL program is designed to train individuals for careers helping individuals, companies, and organizations navigate legal rules without obtaining a JD.”

The MSL program will be a one-year, 28-credit program that will admit students into a specialty track designed to prepare them for a specific area of practice. The inaugural program at Colorado Law will confer an MSL in Patent Law designed to prepare non-JD students, who otherwise meet the technical requirements, to take the Patent Bar Exam and enter the workforce as patent agents. In addition to track-specific patent and intellectual property classes, students in the MSL program will be required both to complete courses introducing them to the U.S. legal system and legal research, writing, and analysis, and to work as an extern in the field.

Patent law was chosen as the first MSL specialty track at Colorado Law in response to an increased need for legal professionals who are eligible to take the Patent Bar Exam. Faculty at Colorado Law spent several months reaching out to law firms and corporate legal departments in an effort to better understand which expertise was most in demand that could be performed by non-JD legal professionals. Colorado Law Scholar-in-Residence **Bill Mooz** ('85) describes the process as an “employment-outcome approach,” designed to best align the career trajectory of MSL graduates with the current job market. “With the launching of a U.S. Patent Office in Denver and Colorado’s emergence

as a technology hub, the demand for patent agents continues to increase and makes this track a natural one to start with,” explained Colorado Law **Dean Phil Weiser**.

Approving a new degree at the University of Colorado requires programs to be approved not only by the Colorado Law faculty and by CU-Boulder campus officials, but also by the Board of Regents. On the Board of Regents, Colorado Law was well represented, with Board of Regents Chair **Kyle Hybl** ('96), Regent **Michael Carrigan** ('94), and Regent **Joseph Neguse** ('09) all voting on the new program. At the meeting this fall, Regent Neguse took the unusual step of moving to approve the program without the customary step of reviewing it at a second meeting. The motion passed unanimously.

For more information, visit colorado.edu/law/msl.

SILICON FLATIRONS MARKS 15TH ANNIVERSARY

There is a moment when a startup ceases to be a startup and becomes an institution. **Brad Bernthal** ('01), associate professor and director of the Entrepreneurship Initiative for the **Silicon Flatirons Center for Law, Technology, and Entrepreneurship**, believes that, after 15 years, Silicon Flatirons has matured into a true institution.

“Start-ups begin as founder-driven ideas, but to be successful they need to develop structure beyond the individual,” said Bernthal. “There needs to be scaffolding, structure, content, and expanding product lines.”

Dean Phil Weiser founded the center in 1999, as part of the school's growing emphasis on innovation in technology and entrepreneurship. In February 2015, Silicon Flatirons commemorated its 15th anniversary at its annual Digital Broadband Migration conference.

The 2015 conference, *The Digital Broadband Migration: First Principles for a Twenty-First Century Innovation Policy*, echoes the theme of the first Silicon Flatirons conference, *Telecommunications Law for the Twenty-First Century*, held when the center launched in February 2000. The center's Digital Broadband Migration conferences have provided a unique forum for a series of conversations around the future of telecommunications and Internet regulation.

As **Tom Wheeler**, chair of the Federal Communications Commission, said at the 2014 conference, “Silicon Flatirons and [Colorado Law are] places where law, policy, and entrepreneurship come together to discuss the present and plot the future. That is a unique contribution to our national dialogue.”

The 2015 Digital Broadband Migration annual conference featured the chairs of the FCC, Tom Wheeler, and of the Federal Trade Commission, **Edith Ramirez**.

Over the past 15 years, the conference has brought together a range of leaders from academia, government, and industry, including many who return each year. Those who have joined every Digital Broadband Migration conference include Dale Hatfield, senior fellow at Silicon Flatirons; Howard Shelanski, Office of Information and Regulatory Affairs Administrator; Judge Stephen Williams, judge of the D.C. Circuit Court of Appeals and former Colorado Law professor, and Ray Gifford, partner at Wilkinson, Barker, and Knauer.

In 2003, the concept of network neutrality was discussed publicly at the conference for the first time, in Columbia Law Professor Tim Wu's paper, “Broadband Discrimination, Network Neutrality,” which was published in the law school's *Colorado Technology Law Journal* (formerly the *Journal of Telecommunications and High Technology Law*). Then-FCC Chairman Michael Powell embraced the concept as FCC policy at the following year's conference. Other Silicon Flatirons conferences have developed and debated network neutrality, along with other leading technology policy issues, including data privacy, the regulation of wireless spectrum, and software patents.

Over the years, the conference has featured leaders from federal agencies, including FCC chairs Michael Powell, Julius Genachowski, and Tom Wheeler, and the recent chairs of the FTC, Bill Kovacic, Jon Leibowitz, and Edith Ramirez. Industry leaders who have addressed the conference include Barry Diller, CEO of IAC; Randall Stephenson, CEO of AT&T; Glenn Britt, CEO of Time Warner Cable; Jim Crowe, CEO of Level 3 Communications; and Richard Notabaert, CEO of Qwest. Other legends who have participated include Internet pioneers Vint Cerf and Robert Kahn, who invented the Internet protocol, and Alfred Kahn, who oversaw airline deregulation.

A generation of Colorado Law students, supported by a series of classes, the journal, the Technology Law and Policy Clinic, and relevant internships (with funding support for those in the public sector) have entered a range of public and private positions in technology policy. Many of those former students return for this annual conference.

In the mid-2000s, Silicon Flatirons emerged as a platform, not only for technology policy leadership, but also for innovation and entrepreneurship. Silicon Flatirons' engagement around entrepreneurship includes its support for the CU-Boulder campus's New Venture Challenge, an Entrepreneurs Unplugged series (which has featured Ted Turner, Charlie Ergen, and David Bonderman, among others), and a Crash Course series.

Colorado Law students also have the opportunity to engage in entrepreneurship through the Entrepreneurial Law Clinic and a range of other curricular and extracurricular opportunities. Both the clinic and the entrepreneurial initiative are led by Bernthal.

Silicon Flatirons' leadership in entrepreneurship has sparked a series of opportunities to support the development of talent both on campus and in the community. Silicon Flatirons is in its fourth year of supporting Startup Colorado, an organization dedicated to making connections between entrepreneurial leaders in Denver, Boulder, Colorado Springs, and Fort Collins, and supporting emerging entrepreneurs. In 2014, Silicon Flatirons was selected for a three-year, \$3 million investment from the Blackstone Entrepreneurs Network, with the aim of building a community of seasoned mentors who can support gazelles that are positioned as breakthrough success stories.

For information on Silicon Flatirons and the Digital Broadband Migration conference, visit siliconflatirons.com.



CLOCKWISE FROM TOP LEFT:

Randall L. Stephenson, Chair and CEO, AT&T.

Julie Brill, Commissioner, FTC.

Brad Feld, Managing Director, Foundry Group.

Edith Ramirez, Chair, FCC.

Travis LeBlanc, Chief, Bureau of Enforcement, FCC.

Mignon Clyburn, Commissioner, FCC.

Judge Stephen F. Williams (foreground), U.S. Court of Appeals, D.C. Circuit.

Dean Phil Weiser, Founder and Executive Director, Silicon Flatirons; and

Dale Hatfield, Adjunct Professor, Colorado Law; Senior Fellow, Silicon Flatirons.

Leslie Harris, President and CEO, Center for Democracy and Technology.

Michael Powell, President and CEO, National Cable & Telecommunications Association; former Chair, FCC.

Kim Jordan, CEO and Co-Founder, New Belgium Brewing Company.

THE LEGACY OF JUDGE CARRIGAN

By Sean Keefe ('17)

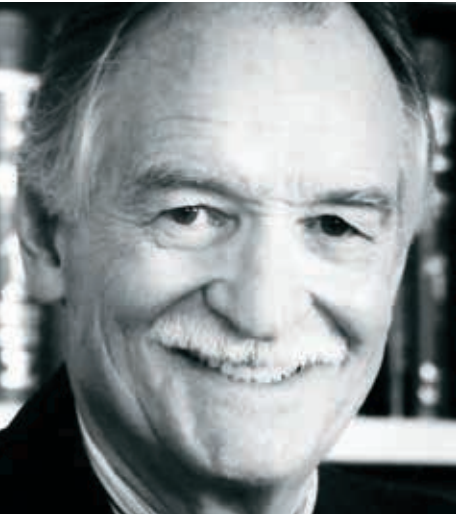

Local Rule 1(a): “Each attorney must approach the bench and tell one joke to the judge before court can proceed.” While the joke would remain off the record, the author of Local Rule 1(a), Judge **Jim R. Carrigan**, would insist that the joke met the common standard of decency. Even more importantly, the joke had to abide by the Carrigan Code.

Many years ago, when a young law student was hitchhiking back to Boulder on I-25 from a conference in Colorado Springs, Jim Carrigan picked him up. It

did not matter that the car was packed with Carrigan children—he was a family man and his family extended to anyone in need. It was the Carrigan Code. That hitchhiking law student, **Ed Perlmutter** ('78), would go on to become a member of Congress and cite that ride in the back of the family station wagon as the beginning of a lasting friendship with one of his idols.

In the 1980s, a drug-addicted bank robber stood before Judge Carrigan on violation of his parole when he could not pay his court fees. Judge Carrigan dismissed the charge against Phil Morgan with the words, “God bless and good luck.” His actions gave the man a second chance. After Morgan could not find work, Judge Carrigan offered Morgan a job working with him in his garden and the opportunity to turn his life around. It was the Carrigan Code. Morgan has been sober since and remains close to the Carrigan family.

Jim R. Carrigan, age 84, a former U.S. District Court judge and justice of the Colorado Supreme Court and University of Colorado regent, died August 15, 2014, in his south Boulder home, surrounded by his wife, Beverly, and his loving family.

Judge Carrigan was born August 24, 1929, in Mobridge, South Dakota, to Michael Leo and Mildred Ione Carrigan. He was raised in Hallock, Minnesota, where his father ran a bakery. Judge Carrigan would go on to study at the University of North Dakota, where he was elected president of the student body and served as editor-in-chief of the law review. He graduated with a BA in philosophy and first in his class with a law degree in 1953.

Always in pursuit of knowledge, Judge Carrigan continued his education at New York University, obtaining an LLM in tax law. However, more important than any degree or piece of knowledge, Judge Carrigan met the love of his life, Beverly Halpin, while in New York City, and the two

were married June 2, 1956. After a brief stint as an assistant professor at New York University, Jim and Beverly moved to Denver when he became a professor of law at the University of Denver.

The Carrigans moved from Denver to Boulder in 1963. In 1969, the family completed their dream home atop a mesa at the base of the Flatirons. The house on the hill served as the perfect venue for many large get-togethers with family and friends. During parties, guests and family members would often lose track of the host. Judge Carrigan could be relied on to turn up in the kitchen, speaking with the catering staff, or with students. It was the Carrigan Code.

Judge Carrigan’s love of knowledge was matched only by his love of the University of Colorado. Five of the six Carrigan children would go on to graduate from CU, including three from the law school: **Sheila** ('82), **Patrick** ('87), and **Michael** ('94). In the new law school building, a courtroom bears his name in tribute to his profound impact, as does a Colorado Law mock trial competition, the Carrigan Cup.

Judge Carrigan’s influence, however, stretched beyond the classrooms at Colorado Law. During his career as a plaintiff attorney, Judge Carrigan was known for standing up for the little guy. Judge Carrigan would often speak out for those who did not have a voice, including those catastrophically injured. In the 1980s, he was one of the first federal jurists to rule that racial profiling was unlawful and decry the inequities of mandatory sentences for crack cocaine. After leaving the bench, Judge Carrigan had a successful career as a mediator and arbitrator, and that included his pro bono determination of allocation of insurance funds to the victims of the Columbine High School tragedy. Honoring his commitment to public service, his family set up the Jim R. Carrigan Loan Repayment Assistance Program Fund in his memory, enabling future generations of law students to be encouraged and supported in public service work.

While his accolades are too extensive to list, all who knew Judge Carrigan knew that he considered his family his crowning achievement. To Jim, the Carrigan family reached beyond his loving wife, six children, and 12 grandchildren to include the hundreds of future lawyers who passed through his classroom, the dozens of law clerks through his courtroom, and the countless strangers met in the Denver and Boulder streets. It is the Carrigan Code and its legacy lives on.

For those wishing to make a gift to Colorado Law in memory of Judge Carrigan, please visit cufund.org/Carrigan.

BROOKE WUNNICKE: HONORING A LEGEND

By Mark Fogg ('79)

One of **David Getches's** last acts as dean was establishing the Brooke Wunnicke Endowed Scholarship Fund to benefit students with excellent academic performances and records of community service or employment before coming to the law school.

On May 9, 2011, when Wunnicke turned 93, David Getches joined her to celebrate their signing the scholarship agreement. From age 12, Wunnicke wanted to be a lawyer. After graduating from Stanford ('39, Phi Beta Kappa), where she met her husband, Jim, she entered law school when he entered military service, graduating from Colorado Law in 1945, *Order of the Coif*.

This past fall, Wunnicke died peacefully while she slept, after 96 years of a remarkable life. For generations of lawyers, Wunnicke's mentorship and example of what it means to be a lawyer lives on. At Colorado Law, Wunnicke's inspiration is captured by a nook in the library, where her personal desk (used for 86 of her years), a reading chair, a memorial plaque, and memorabilia will remind law students of a legal legend. Another tangible legacy of Wunnicke's career and contributions will be her endowed scholarship.

Wunnicke was a trailblazer, who received many awards. Her pioneering spirit led her to be Wyoming's first practicing woman trial lawyer, representing clients in front of juries when women in Wyoming (the first state to allow women to vote) were not allowed to be jurors. In her words, women were "about as common as an aardvark in the courtroom," and some judges made her wear a hat in court, at a time when ladies wore hats in church.

She had years of substantial experience in a broad range of legal areas: trials (she never lost a jury trial) and appeals in state and federal courts (over 250 appeals, many by referrals); business law; general law, including probate, wills, and taxes; real estate; and securities law.

She also had a series of firsts, including in 1981 being the first woman to deliver a commencement speech at Colorado Law. In 1997, she received Colorado Law's William Lee Knous Award, Colorado Law's highest alumni honor.

In 1969, Wunnicke moved to Colorado with her husband (who died in 1977) and, because of her trial and appellate record, was thereafter asked to serve as chief appellate deputy district attorney from 1973-1986. This is where I met Brooke. She was a guiding light on trial and appellate practice and on legal ethics, and a mentor par excellence.

Velveta Golightly-Howell ('81), for example, recalls how Wunnicke "made the office a true home, regardless of your background. Her influence to this day is beyond measure." I recall how "on every brief, she would have you sit right next to her while she went through the brief line by line with you. The famous red pen would appear" and provide valuable guidance.

Craig Silverman and **Bill Ritter**, also of the class of '81, turned to Brooke for mentorship. Bill Ritter, as governor, offered a special proclamation on her 90th birthday. Silverman related that "Brooke was the best lawyer I have ever known. Brooke mentored me and so many other young lawyers, and we could not have had anybody better."

After leaving the district attorney's office, Wunnicke joined Hall & Evans LLC as of counsel and also was a consultant, expert witness, adjunct law professor, a frequent lecturer in the United States about legal ethics and professionalism, and an author of business law books.

The firm's announcement of her retirement in 2011 extended its warm wishes and summarized her career: "Through her many years, until 2011, of dedicated service to the legal profession as a trial and appellate attorney, business advisor, mentor, adjunct professor, consultant, and published author, Wunnicke earned the distinction as one of Colorado's most honored legal professionals. Wunnicke's unwavering commitment to the ethical practice of law through her teachings and personal practice leaves an indelible mark on the legal profession."

Hall & Evans LLC, which had supported a Brooke Wunnicke scholarship during her affiliation, is supporting the endowment of a lasting Brooke Wunnicke Scholarship by making a very generous contribution.



For those wishing to make a gift to Colorado Law in memory of Brooke Wunnicke, please visit cufund.org/Wunnicke.

2015 COLORADO LAW ALUMNI AWARDS BANQUET

To view slideshows and videos from the March 11, 2015, alumni awards banquet, visit colorado.edu/law/banquet.





Each year, the Colorado Law Alumni Awards Banquet celebrates the considerable achievements of our alumni community. Honorees are selected by the Law Alumni Board in September. To nominate a deserving alumnus, send a brief statement in support of the nomination to lawalum@colorado.edu.

Photography generously donated by Nicola Leigh Photography, nicolaleighphotography.com.

NEWS

BRUFF PUBLISHES BOOK

Hal Bruff, Nicholas Rosenbaum Professor of Law and former dean of Colorado Law, has published a new book, *Untrodden Ground: How Presidents Interpret the Constitution* (University of Chicago Press, 2015). The book examines how all 44 presidents have responded to pressing matters by setting new legal precedents, which often developed into standard practices. Bruff delves into how commanders-in-chief have relied on both their predecessors' and their own interpretations of constitutional text.

Based on these understandings, presidents then establish policies neither forbidden nor mandated by law in order to expand executive power well past original boundaries. Bruff argues, however, that the modern presidency remains properly limited by national political methods. He maintains that unpopular measures result in public uproar, nullification by the judiciary, reactive legislation, or impeachment, while actions taken by the president that ought to be within presidential powers go unchallenged by Congress and the people. On October 15-16, 2015, the Byron R. White Center's Ira C. Rothgerber, Jr. Conference will bring scholars from around the nation to Colorado Law to discuss *Untrodden Ground* and the important questions it raises about presidential interpretation of the Constitution.

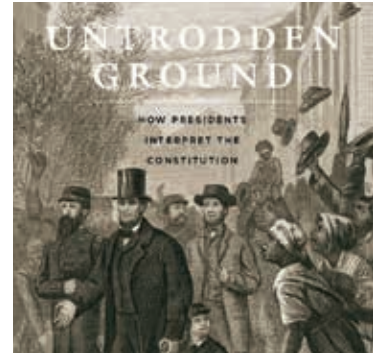

GAZUR TO RETIRE

After 29 years of teaching at Colorado Law, Professor Wayne M. Gazur ('81) will retire in June 2015. An abiding childhood fascination with business legal issues prompted him to study accounting. The American Institute of Certified Public Accountants awarded the Elijah Watt Sells certificate of honorable mention for his performance on the May 1976 CPA exam (in 2013, for example, 55 candidates out of 94,154 were so recognized). He practiced for several years with a national accounting firm before attending law school, graduating *Order of the Coif*.

Professor Gazur spent five years in private practice in Denver, completing an LLM in taxation during that time, before accepting a position at the University of Colorado in 1986 as a full-time lecturer in business and law. After four years, he was appointed as an associate professor in both the business and law schools. In 1999, he became an associate professor solely in the law school, and three years later he was promoted to the rank of full professor. He taught a dozen different courses, and in 2003 he received Colorado Law's Alumni Award for Distinguished Achievement (Education). Professor Gazur published extensively on tax (notably, foundational articles about limited liability companies), as well as on estate planning (*Estate Planning—Principles and Problems*, an innovative law school textbook, co-authored with Robert M. Phillips ('93), is now in its fourth edition). In his words, "It was a special privilege for me to teach such exceptional students at my alma mater."



CONNOR GIVES GETCHES-WILKINSON CENTER DISTINGUISHED LECTURE

The Getches-Wilkinson Center for Natural Resources, Energy, and the Environment held its second annual distinguished lecture in March 2015. Michael Connor ('93), deputy secretary of the U.S. Department of the Interior spoke on "Expanding the Watershed: Certainty and Sustainability in 21st Century Water Resources Management" to a full house at Wittermyer Courtroom in the Wolf Law Building. As deputy secretary, Connor is a key leader in water policy and relations, as well as the head of the department's land buy-back program.

The Getches-Wilkinson Center's distinguished lecture series was designed as a cooperative venture between the Getches-Wilkinson Center and the *Colorado Natural Resources, Energy & Environmental Law Review* to bring to the University of Colorado a distinguished figure in the field of natural resource, energy, and environmental law and policy. The distinguished lecture series provides a forum for thought leadership, allowing distinguished lecturers to reflect on their experiences, and to provide insight on current issues.



GRUBER AND PEPPE CO-AWARDED FELLOWSHIP

Professors Aya Gruber and Scott Peppet have been co-awarded the 2015 Goldstein Fellowship. MDC/Richmond American Homes Foundation established the Gilbert Goldstein Fund in recognition of the dedication and generosity of alumnus **Gilbert Goldstein** ('42) to the greater Denver legal community. The fund provides scholarships and fellowships to deserving Colorado Law students and faculty. The fellowship provides two semesters of research funding to a faculty member.

Gruber and Peppet submitted very compelling applications, and they will split the fellowship to pursue their research. Peppet will be continuing his research on technology and information privacy, especially on the "Internet of Things" and the privacy implications of connected devices. He will also be enrolling in the new, one-year Master's in Finance program at the University of Colorado's Leeds School of Business. Gruber will use the semester to work on a book project, tentatively titled *The Feminist War on Crime*. She has published several articles analyzing feminist law-making in the context of other trends in criminal law, such as mass incarceration, racialized policing, and sentencing reform. She intends the book to provide a comprehensive understanding of the costs and benefits of using criminal law as a tool of women's liberation.



DIVERSITY PANEL PROVIDES GUIDANCE TO STUDENTS

With a focus on professionalism, **Dean Phil Weiser** and **SuSaNi Harris**, senior director of diversity and inclusive excellence, coordinated an insightful discussion with students titled, "How to Handle Diversity and Inclusiveness Issues in the Workplace." The panel of experts included **Franz Hardy** ('00), Gordon & Rees, LLP; **Karen Hester**, Center for Legal Inclusiveness; **Meshach Rhoades** ('04), Greenberg Traurig, LLP; and **Shannon Stevenson**, Davis Graham & Stubbs, LLP.

Speaking with students, the panel explored whether diverse teams really reach better results for their clients. Students asked thoughtful questions and received guidance on how to handle challenging situations and how to be effective.

Students also had the opportunity to learn what legal employers are doing to overcome the impact of implicit bias in the workplace. "In working with Dean Weiser and numerous others, I am impressed that Colorado Law executes on the 'life cycle' of building a diverse and inclusive community. From recruiting faculty and students, to providing education and support in classrooms, to connecting alumni and allies, the school has truly built an inclusive and collaborative community," said Hardy.



WILLIAMS JOINS COLORADO LAW

Julie Ann Williams joined Colorado Law in January 2015 as assistant director of events and alumni relations. Previously, Williams served as a marketing communications specialist for The Toro Company in Bloomington, Minnesota, where she was responsible for public relations, corporate communications, and event planning. Williams was active in her undergraduate campus community, serving as senior class president, a resident advisor, and as a member of the student activities and recreation board. She is excited to help advance the mission of the law school through community events and engaging with alumni. Williams graduated from the University of St. Thomas in 2007 with a BA in business communications.



STUDENTS LEARN FROM TOP IN-HOUSE GENERAL COUNSEL

By Alexandra Berger ('16, Oberlin College)



Fiona Arnold
Vail Resorts



Susan Blount
Prudential



Mark Chandler
Cisco



Randy Milch
Verizon



Kim Rivera
DaVita



Mark Roellig
MassMutual



Laura Stein
Clorox

This January, Colorado Law offered an innovative way for practicing attorneys to enhance their skills and for enterprising students to prepare for today's job market. The Corporate Counsel Intensive Institute (CCII) is a one-week course taught by seven current or former Fortune 500 General Counsel from across the country. Twenty-seven in-house lawyers signed up to learn from leading practitioners and each other, alongside 20 students who had the opportunity to gain an invaluable look into real world in-house counsel work.

The course started two years ago as a one-week Introduction to In-House Counsel course taught to Colorado Law students by **Mark Roellig**, the current executive vice president and general counsel of Massachusetts Mutual Life Insurance Company. Before joining MassMutual, Roellig served as general counsel and secretary for Fisher Scientific International, Inc., Storage Technology Corporation, and U.S. West, Inc. The second year he taught the course, Roellig brought two of his colleagues from MassMutual to take the class. They found it so helpful that Roellig decided to re-structure the course by opening it up to in-house attorneys and inviting six Fortune 500 general counsel to teach with him. Each general counsel was given the opportunity to bring along two in-house colleagues to take the course. Roellig found the addition of attorneys to the classroom to be important because it provided students with invaluable networking opportunities and gave everyone involved a broader perspective on in-house practice.

Each day of the week-long course featured different general counsels discussing how they tackled various aspects of working in-house. Monday's class was led by **Kim Rivera**, chief legal officer and secretary of DaVita Healthcare Partners, Inc., and **Laura Stein**, senior vice president and general counsel of The Clorox Company. They reflected on the role of in-house lawyers and also shared elements of their professional relationship, which started when Stein mentored Rivera.

"You do not need followers in order to be a leader," quipped **Randy Milch**, executive vice president and general counsel of Verizon Communications, Inc., who taught the second day of the course. His class focused on leadership and emphasized the idea that bosses have a responsibility to keep their employees' best interests in mind.

Mark Chandler, senior vice president, general counsel, and secretary of Cisco Systems, Inc., and his colleague **Steve Harmon**, vice president and deputy general counsel, discussed how to manage the legal needs of an organization on the third day of the course. The nitty-gritty of business processes from their class contrasted greatly with the more personal advice that characterized **Susan Blount's** Thursday class. Blount serves as executive vice president and general counsel for Prudential Financial, Inc., and she brought her experience to bear on her discussion of the skills needed to succeed in-house. She offered plenty of advice, as applicable to life as to work, encouraging the class to "hold on tight and embrace change," because change brings about winners and losers, and those who fight change will lose. Like Rivera and Stein, she also advised the class to "take the biggest, hardest, gnarliest job you can."

Fiona Arnold, former executive vice president and general counsel for Vail Resorts, Inc., and current executive director of the Colorado Office of Economic Development and International Trade, and Roellig worked together to organize CCII this year and co-taught the final class. Arnold stressed that it is a lawyer's job to think individually and fight for one's legal opinions. Roellig concluded the class by re-stating that ethics, integrity, sound and decisive judgment, interpersonal skills, business and accounting knowledge, and a positive attitude are essential to succeeding as an in-house attorney.

At a reception for CCII participants, **Dean Phil Weiser** announced that the students and attorneys who participated in the program are "at the cusp" of defining how the future of law will look—with more students going straight from law school to corporate counsel roles and skipping the traditional training at law firms. The future of the CCII looks as promising as the participants. Roellig believes the course "raises the stature of Colorado Law" and hopes more students and attorneys will attend next year, as word spreads about the unique educational opportunity the program offers.

GIFTS AND GRANTS



LEFT TO RIGHT: Norm Brownstein ('68), Dean Phil Weiser, and Steve Farber ('68)



John Ikard



Steve Hilliard ('76)

LARGEST LAW FIRM GIFT SUPPORTS PUBLIC SERVICE

Brownstein Hyatt Farber Schreck, LLP generously donated \$500,000 to be divided between the University of Colorado Law School and the University of Denver Sturm College of Law, to create endowed fellowship programs. It is the largest single gift from a law firm in the histories of both schools.

Colorado Law plans to use its \$250,000 to support a class of five Brownstein Hyatt Farber Schreck fellows, who will receive summer stipends to perform public sector work. Students will benefit from the firm's generosity and contribute to the firm's legacy of supporting public service.

"Brownstein Hyatt Farber Schreck is a special firm in the pantheon of Colorado Law," remarked **Dean Phil Weiser**. "Founded by graduates of Colorado Law, the firm, with all of its successes, its tradition of supporting public service, and its national reputation, is a point of pride for the law school."

Nearly 30 percent of Brownstein's attorneys are alumni of Colorado Law, including founding members and current members of the firm's executive committee, **Norm Brownstein** ('68) and **Steve Farber** ('68), who founded the firm along with classmate and friend Jack Hyatt ('68).

COLORADO LAW SELECTED AS FIRST LAW SCHOOL TO JOIN THE DANIELS FUND ETHICS INITIATIVE

The University of Colorado Law School was selected as the first law school to participate in the Daniels Fund Ethics Initiative. The support of the Daniels Fund will allow Colorado Law to make ethics a central part of every law student's education, supporting and advancing the school's firm belief in the importance of developing legal professionals who are capable of acting as principled leaders, entrepreneurs, and problem solvers. In February, Colorado Law hosted the inaugural Daniels Fund Ethics Initiative at Colorado Law Lecture, presented by John Ikard, president and CEO of FirstBank Holding Company. Ikard spoke on "Leading an Ethical Organization in a Sometimes Unethical World."

Reflecting Bill Daniels' personal commitment to ethics and integrity, the Ethics Initiative was established in 2010 to strengthen the teaching of principle-based ethics, fostering a high standard of ethics in students—even beyond the campus and into the community. The Daniels Fund Board of Directors approved funding for a second five-year term of the Initiative. Three new colleges were accepted into the Ethics Initiative, which now includes 11 schools from eight universities.

ALUMNUS ESTABLISHES MENTORSHIP PROFESSORSHIP

Steve Hillard ('76) pledged \$1.5 million to endow the Council Tree Professorship, to be awarded to a law faculty member who contributes to the success of students through active mentorship, hands-on engagement, and a commitment to supporting diversity. "Diversity is important to me and always has been," said Hillard. "Empowerment, enablement, entrepreneurship—those are my buzzwords."

"The Council Tree Professorship is a wonderful gift to Colorado Law," said **Dean Phil Weiser**. "It will be awarded to faculty members who truly engage with students and help launch them into successful careers. These are the professors we need to attract and keep." With his gift, Hillard has the following message to students: "Your law degree will be a wonderful ticket to do just about anything. I hope the Council Tree Professorship adds a little something to your path."

LOYAL DONORS

We gratefully acknowledge individuals who have given to Colorado Law for five or more consecutive years. These loyal donors exemplify the spirit of giving and are important members of the Colorado Law community. We strive to provide a complete and accurate list. Please contact us at giving@colorado.edu should you notice an omission.

30 YEARS

Mitchell and Martha Benedict
Dick and Linda Bump
Richard Collins and Judith Reid
Lindsay Fischer
David and Laura Fisher
Dan and Marcy Haskell
Philip Heinicke
Tom and Alison Henry
Carolyn and Sam Johnson
Cameron Kirk*
George and Carolyn Lyman
Tom Melaney
Susanne Miller
Gary and Brooke Palumbo
Judith and Lawrence Schulman
Steve and Jane Sinton
Mary and Dave Steefel
Kathleen Trachte
Pete Wall
Kirby and Irene Wells
Matt and Julia Wills
Bill and Marie Wise

20 YEARS

Rich and Jean Arnold
Edgar and Barbara Brandenburg
Ronald Brodsky
Dick and Beverly Gast
James Guyol
Tom and Deborah Horgan
Bill and Lynda Johnson
Richard Kadinger
Chuck and Babs Kall
William Kemp
Neil* and Gretchen King
Howard and Barbara Klemme
Jim and Carole McCotter
Jay and Kathy Montgomery
Georgianne Pavlica and
Richard Breidenbach
Garth and Joanne Rogers
Elizabeth Rohrbough
Marty and Alec Rolle
Donna Schmalberger and
David Lichtenstein
Donald Slavin
Susan Stearns and Frank O'Loughlin
St. Clair Strong
Ken and Barb Stuart
Robert and Betty Tuchman
Christopher and Leanne Walther
Bill and Ludene West
Janet Christine Wygle
John Wilson
Steven Zwick

10 YEARS

Norm Aaronson
Ann Alison
Marilyn Averill
Thadd and Mary Baker
Gabriel and Lynne Banfi
Ken and Carolyn Barnhill
Betsy Beaver
James and Sue Bicknell
Christopher and Margot Brauchli
Marc and Stacey Brosseau
Hal and Sherry Bruff
Jim Bruin
Harold and Brenda Bruno
Jim Burack
Al Canner and Claudia Naeseth
Marriner Cardon
Charlton and Christa Carpenter
Michael and Sarah Carrigan
Jim Casebolt and Nancy Williams
Jane Christman
Brian Connors
Rhonda and William Crossen
Vicki and Sam Dazzo
Stan and Judy Dempsey
Carl "Spike" and Nan Eklund
Scott Evans and Ellyn Henders
Larry and Susan "Archie" Farin
George and Linda Fewson
Dick and Ann Fisher
Robert and Gail Ford
Pat Furman
Jean Garland and Bruce Byers
Hugh and Jeanne Gottschalk
David L. and Melinda Harrison
Sue Ellen Harrison
Russ and Susan Haskell
Sheryl Howe
John Hay and Ruth Murphy
Michael Henry
Jack and Andrea Hyatt
David Johnson
Jim and Pam Keeling
Stuart and Lauren Kingsbery
Merrie Kippur
James and Carol Knapp
Jon and Lenna Kottke
Michael and Tammy Lindsay
Joanne Little
Mark and Linda Loewenstein
Ronald and Jeris Loser
Margaretha Maloney and Robert Palaich
Philip and Linda Mangones
Chad and Ann Milton
Steve and Beth Moise
Bob and Jane Nagel
Kathleen Nalty and Craig Shaffer
Alex Nelson
Dave and Ann Phillips
Florence J. Phillips
John Popovich and Nancy Juday
Tom and Teresa Rice
John G. Richardson

Tom and Bev Schatzel
John H. Schultz
Kevin Shine
Stan Stanfill
Shawn Stigler
Doug and Leslie Weddell
Anja Wendel
William and Jo-Ellen Wickwire
Amy and Philip Winterfeld
David and Carol Wood
John and Marsha Yeager
Luize Zubrow and Bingham Leverich

5 YEARS

Lance Astrella
Phillip Barber
Marty and Brenda Becker
Kevin and Elizabeth Bell
Michael and Diane Boucher
Brenna and Roger Brackett
Joel and Carol Brosk
Cindy and Jack Bruner
Tammy Campbell
Libby Cook and Joan Knudson
Brad and Judith Coover
Frank Crociata
Cecilia and Glenn Curtis
Harvey and Marlene Curtis
Harold and Diane Davison
Louis Deluca and Victoria Faoro
Wells Dixon and Alison Sclater
Stanley and Maggie Doida
The Honorable and
Mrs. Richard P. Doucette
Matt Douglas and Alex Band
Scott Dunbar
David Eisenstein and Monica Ely
Katie and Jeff Elsner
Chuck and Virginia Ennis
Tim Enwall and Hillary Hall
Brad Feld and Amy Batchelor
Connie and Russell Fields
Steven and Ellen Finer
Michelle Flores
Ann and Ford Frick
Alex Furman
Cass and Barry Gassman
Mitchel and Janice Goldberg
John and Lois Greer
Fred and Michelle Hamel
Mark and Kim Hamilton
Marilyn Frison Hand
Melissa Hart and Kevin Traskos
Dale and Pat Hatfield
Alan and Jerry Heath
Chris and Linda Hedemann
Stanley and DeArliis Henderson
John and Cynthia Hilson
Greg and Barbara Hobbs
Marisa Hudson-Arney and Ryan Arney
Bill and Kathleen Hybl
Alice Ierley and Steven Moss

Will and Judy Iwai
Nora Jacquez
Fred and Katrina Jeynes
Danielle and Steven Johnson
Michael and Cathy Kane
Nicholas Kant
Danielle and James Keith
Sarah Krakoff and John Carlson
Jamie and Alan Kwiatek
James Lamme and Wendy Linscott
Ed and Judy Lee
Connie Lewis
Louis and Carol Lobenhofer
Tom and Kristen Magee
Krista Marks and Brent Milne
Thomas Martin
Alex and Katherine Martinez
Kevin McDowell and Joan Norman
Michael and Jessica McGawn
Margaret McIntosh and Larry Kramer
Jason and Jennifer Mendelson
Chad and Ann Milton
Bill Mooz
Bill and Bonnie Neighbors
Jim Nelson
Henry and Linda Neuman
Sarah and Matthew Niess
Helen Norton and Kenny Johnson
Bill and Kris Paddock
Sara Page and Solomon Baron
Sarah Peay
Loretta Pickerell and Larry Edelman
Cyrus Rajabi
Susan Rehak and Keith Maskus
Ann Roan and James Jenkins
Kristin and Allen Rozansky
Josephine Ruder and Robert McKenzie
Michael Savage
Allison and Andrew Schwartz
Karen and David Selden
Michael and Barbara Shangraw
Jerry and Jan Shelton
Greg and Nancy Signer
Heather Smith and William Nonneman
Bob and Jan Steiert
Holly Sterrett and Roscoe Nelson, IV
Lee Stigler
Linda and Dana Sundberg
Tucker and Beatrice Trautman
Craig Truman
Marc Ungar
Doug and Leslie Weddell
Mary and Jim White
Maya and James Wilbourn
Stow and Margaret Witwer
Ruth and Kenneth Wright
Carole Yaley

*Deceased

LETTER FROM THE ALUMNI BOARD CHAIR

Laura Sturges ('05)

Dear Colorado Law Alumni,

When students and alumni describe Colorado Law and its culture to prospective students, a consistent theme emerges: its cooperative and collaborative environment. One of Colorado Law's strengths lies in its ability to bring together individuals of different backgrounds, beliefs, experiences, and interests and unite their diverse perspectives in a shared pursuit: the study of law. An important part of the Colorado Law experience is this feeling of teamwork among students, faculty, and the wider community.

In the law school setting, and later as we enter practice, collaboration, diversity, and inclusiveness operate as three legs of a stool. Without all three, we are off balance. Problem-solving is made more effective by seeking out, encouraging, and heeding diverse viewpoints. This balance requires an environment in which those with different perspectives feel comfortable expressing them, and where not only the viewpoint, but the person expressing it, is valued.

As lawyers, the benefits of such collaboration cannot be underestimated. Our day-to-day tasks involve problem-solving. By welcoming diverse viewpoints, the proposed solution ultimately provides more value to the clients we serve, having been examined from a variety of viewpoints.

Colorado Law is committed to fostering a collaborative environment and provides many ways through which students can express themselves and explore their interests, their commonalities, and their differences. Whether through specialty bar student organizations, clinical experiences, student government, moot court, faculty research assistance, or any of the other opportunities for student engagement, Colorado Law strives to give every student a voice and to value each individual's perspective and experiences.

It is no secret that the legal profession and law schools face challenges in promoting and fostering diversity and inclusiveness. The good news is that these challenges provide opportunities for positive change. As Colorado Law alumni, each of us can help our law school and our profession to promote a diverse, inclusive, and collaborative community.

Assist with pipeline projects aimed at encouraging diverse and underrepresented individuals to consider a career in law.

Lend your experience, viewpoint, and support to student organizations at Colorado Law that interest you by serving as a resource for students.

Mentor. Whether you mentor a prospective student, a law student, a recent graduate, or a junior attorney, you can have a tremendous impact on someone's career trajectory.

Recognize instances in which an affinity bias may be at play in your own actions and adjust accordingly. For a fascinating look at implicit-association tests and affinity bias, take a look at the work done through Project Implicit (www.implicit.harvard.edu/implicit/).

Thanks to all the alumni out there (especially my 2005 classmates!) for making Colorado Law such a special and supportive environment.



Law Alumni Board

The Law Alumni Board is made up of 28 Colorado Law graduates. The members promote the best interests of the law school by stimulating interest in, building loyalty for, and increasing support for the law school among its alumni and students, and assisting the law school in serving the needs of its alumni, students, and faculty, the legal profession, and the public at large. The 2014-2015 board chair is **Laura Sturges** and the chair-elect is **Franz Hardy**.

Thomas Brown ('64), Dufford & Brown, PC

Bethiah Beale Crane ('79), Crane & Tejada PC

Darla Daniel ('01), Colorado State Bank and Trust

Judge J. Eric Elliff (Past Chair) ('87),
Denver District Court, 2nd Judicial District

W. Harold "Sonny" Flowers, Jr. ('71),
Hurth, Sisk & Blakemore LLP

Mark Fogg ('79), COPIC Companies

Chris Gaddis ('04), JBS USA Holdings, Inc.

Hugh Gottschalk ('79), Wheeler Trigg O'Donnell LLP

Marc H. Graboyes ('96), CytoBiotics, LLC

Bill Gray ('66), Purvis Gray, LLP

Sarah Heck Griffin ('84), Jones Day

Franz Hardy (Chair-Elect) ('00), Gordon & Rees, LLP

John Hay ('64), Gust Rosenfeld, P.L.C.

Marisa Hudson-Arney ('01), Condit Csajaghy LLC

Carolyn McIntosh ('81), Squire Patton Boggs (US) LLP

Ben M. Ochoa ('87), Lewis Roca Rothgerber LLP

Siddhartha Rathod ('07), Rathod | Mohamedbhai LLC

Meshach Rhoades ('04), Greenberg Traurig, LLP

Ann M. Roan ('89), Colorado State Public Defender

Regina M. Rodriguez ('88), Faegre Baker Daniels LLP

Kristin Rozansky ('94), State of Colorado,
Department of Personnel & Administration

Michael R. Savage ('96), U.S. Trust

Lance Sears ('75), Sears & Associates, P.C.

David Steefel (Past Chair) ('78)

Lucy Stark ('98), Holland & Hart LLP

Laura Sturges (Chair) ('05), Gibson, Dunn & Crutcher LLP

Andrea Wang ('01), Davis Graham & Stubbs LLP

Maureen Weston ('92), Pepperdine University School of Law

ALUMNI OF THE MONTH



Judge Elizabeth Brown ('86)
August 2014

Growing up as one of six children of a judge in Lincoln, Nebraska, the Honorable Elizabeth Brown fondly remembers watching her father try cases all morning and then going home and talking through the issues with her father over lunch. Judge Brown graduated *Order of the Coif* from Colorado Law and served as managing editor of the *University of Colorado Law Review*. She has been a bankruptcy specialist for the last 25 years and a federal bankruptcy judge for the last 13 years. To her, the ability to serve the public by making decisions that have an impact on the lives of ordinary people is very rewarding.



Sally Hatcher ('97)
September 2014

Sally Hatcher has spent the last 15 years as a high-tech entrepreneur and is currently growing her second Boulder-based business, MBio Diagnostics. In 2009, she and her husband, Dr. Christopher Myatt, co-founded the company, which develops simple solutions for the in vitro diagnostics and life sciences markets. Growing up, Hatcher enjoyed science, theater, and travel. Before attending Colorado Law, Hatcher worked as a business analyst at McKinsey and as a raft guide on the Arkansas River. Currently, Hatcher volunteers on boards and invests strategically to help other organizations clarify their visions and grow. She has relished the opportunity to build new businesses, hire great employees, and help create the type of work environment that gets her excited to go to work every day.



George Brauchler ('95)
October 2014

George Brauchler is district attorney for the 18th Judicial District, the largest judicial district in Colorado. As an Army reservist since 1996, he has served on active duty during two mobilizations since 9/11. A veteran litigator, Brauchler has taken more than 140 trials to verdict in state, federal, and military court over the past 18 years. He has been a regular adjunct faculty member of the University of Denver College of Law, Colorado Law, and the U.S. Army and U.S. Navy JAG Schools, earning a reputation as one of the most prolific lecturers and trainers on trial advocacy in the nation. Brauchler serves as a lieutenant colonel in the Army Reserve. He and his wife are raising four young children and Brauchler is a cub master for his children's Cub Scout pack.



Wayne Forman ('84)
November 2014

Born and raised in Long Island, New York, Wayne Forman graduated *Order of the Coif* from Colorado Law in 1984. Forman is currently a shareholder with the Denver firm of Brownstein Hyatt Farber Schreck, LLP. An active contributor to the Rocky Mountain Chapter of the Juvenile Diabetes Research Foundation, Forman is also chairman of the board for the Jefferson County Open Space Advisory Committee, where he has served for the past 20 years. In addition, Forman co-chaired the class of 1984 class reunion which had a great turnout. Forman met his wife, Liz Wald, at Colorado Law and the two have been married for 29 years.



K.C. Groves ('91)
December 2014

As the managing director of Ireland Stapleton Pryor & Pascoe PC, K.C. Groves focuses on complex commercial litigation and has been selected as a Colorado Super Lawyer for business litigation in each of the past eight years. After graduation he joined his father's boutique litigation firm, Groves & Butcher LLC, then moved to the Denver office of Reinhart Boerner & Van Deuren when his father retired in 1999. Then he joined Ireland Stapleton Pryor & Pascoe and is grateful for the guidance he received from Denver legal legend Monte Pascoe. True to Pascoe's vision of putting younger attorneys with longer career horizons in top managerial positions, the firm's directors elected Groves as managing director at the age of 38.

To read full stories, visit colorado.edu/law/alumni-of-the-month.

RECENT GRAD ESTABLISHES NONPROFIT

Promising Start: Taber Ward ('12)

Since graduating from Colorado Law, **Taber Ward** ('12) has pursued her passions for food, health, and public policy. During law school, she held two externships with the Colorado Department of Public Health and Environment and she accepted a full-time position with the department after graduation. In addition to her more traditional position as a policy analyst, Ward applied the entrepreneurial acumen she developed at Colorado Law to found the Mountain Flower Goat Dairy, a nonprofit urban agriculture project in downtown Boulder, of which she is now executive director.

Ward describes the dairy as “a social enterprise providing a platform for food system and agricultural policy reform through our raw milk goat dairy, volunteer programs, tours, farm-to-school initiatives, and educational opportunities.” Her typical workday can be filled with activities from both the legal and the agricultural realms. She might start with hands-on farm chores like milking goats and building fences and oversight of staff and volunteers, then merge into the more academic tasks such as urban agriculture curriculum development, grant writing, and nonprofit management and fundraising.

To start the dairy, Ward approached the landowners of the historic 25 acres of urban agriculture land and asked if they would consider allowing a community dairy on the property. She submitted a business plan and took out a loan to start the farm.

In contrast, she also works in a more traditional role for the Colorado Department of Public Health and Environment (CDPHE) as a legal and policy analyst, focusing on public health law and obesity policy in Colorado. A typical workday at the office includes legislative research, administrative legal research and memorandum writing, policy and program implementation, and meetings with other agency members to work on comprehensive health and obesity policies.

She secured her position with the CDPHE through the law school's externship program. After externing during her second and third years, she was offered a position. Ward found the externship program to be extremely helpful in obtaining a job for two reasons. First, she had a chance to see what type of work she liked to do with only a semester's commitment. This provided insight into the legal field as well as her own strengths and challenges. Second, she notes that she was never in the top 10 percent of students at Colorado Law, so the externship program gave her an alternative way to show a potential employer that she was smart, eager, hardworking, and a team player by demonstrating so in the field instead of just relying on her résumé.

Ward credits Colorado Law with helping her to develop and hone skills in numerous areas such as legal research, writing, statutory interpretation, nonprofit law, and negotiation, which she now uses on a daily basis, both for the CDPHE and the farm. In addition, Ward feels that being an attorney has given her credibility and advanced the position of the farm. People trust the food safety of the dairy's raw milk because she works in food safety for the state. Consumers trust that she will



understand and follow safety regulations and best practices because it is part of her ethical and professional responsibility.

Notes Ward, “Urban farming in Boulder is incredibly political due to the land uses involved. My legal skills have helped me navigate political issues and innovate on the dairy. Additionally, as an employee of the state, I sit on the Colorado Farm to School Task Force. This has been an amazing professional network for me in both my legal and farming careers as I now have connections to the agencies and industries that are helping to change the food system for the better.”

Read more in the Promising Start series at colorado.edu/law/promisingstarts.

IN MEMORIAM

BROOKE VON FALKENSTEIN WUNNICKE ('45) died at her home in Denver on September 20, 2014. Wunnicke was raised in California and from age 12 wanted to be a lawyer; she graduated from Stanford (BA '39, Phi Beta Kappa) where she met her husband, Jim, from Wyoming. She graduated from Colorado Law in 1945, earning *Order of the Coif*. A pioneer woman lawyer, Wunnicke opened her Cheyenne practice in 1946. After their 1969 move to Denver, because of her well-known trial and appellate record she was asked to serve from 1973-1986 as chief deputy of appeals in the Denver District Attorney's office. From 1986-2011, she was of counsel to Hall & Evans, LLC. Wunnicke provided years of outstanding service to the legal profession as a trial and appellate attorney, business advisor, mentor, adjunct professor, consultant, and published author, and she demonstrated an unwavering commitment to the ethical practice of law through her lectures and writings.

ROBERT D. INMAN ('47), a native of La Junta, Colorado, passed away on October 24, 2014, at age 94. Inman served in the Army from 1942-1946 before returning to Colorado to attend law school. As a public servant, Inman worked in the U.S. Attorney's Office from 1953-1961, after which he co-founded a private firm in Denver. Inman's first wife died in 1968 and he remarried Betty June Smyth the next year, enjoying the lifelong company of five stepchildren. Inman participated in many choral activities and the Denver Rotary Club. His friends and family describe him as kind, gentle, and affable.

JOHN SPENCER FOLAWN ('48), Col. U.S. Army (Retired), passed away in his home in San Mateo, California, on December 13, 2014. Following his wartime service, Folawn graduated from Colorado Law and worked briefly with Shell Oil Company. In 1949, he reentered the military as a judge advocate and had a distinguished 26-year military career, eventually being sworn in as an appellate military judge of the U.S. Army Court of Military Review. Following retirement from the Army, he served as attorney-advisor for the Presidio and then as a member and officer of Project 90. He was preceded in death by his first wife, Catherine Ann, and is survived by his wife, Sue Bassett Folawn, his two children, three stepchildren, 11 grandchildren, and 10 great-grandchildren.

FRANK GIDEON COOLEY III ('51), a World War II veteran, avid skier, reader, and practicing attorney for more than three decades, passed on August 3, 2014, at age 91. Cooley worked as an attorney for the White River Electric Association from 1968 until his retirement in 2001. In 1976, President Ford appointed Cooley to serve as chairman for the Arkansas River Compact Administration, and four subsequent presidents re-appointed him to that post. Cooley also chaired the Oil Shale Regional Planning Commission in the mid-1970s. He is survived by two children, Andrew and Karen, and one granddaughter, Micaela, whom Cooley described as his "pride and joy."

JOHN POWER HOLLOWAY SR. ('51), former mayor of Boulder and longtime resident legal counsel for the University of Colorado, died at his home on October 4, 2014. He served in the U.S. Navy, on the Boulder City Council, and with the Colorado Attorney General. Holloway will be remembered as a consummate professional, renowned attorney, and dedicated public servant. He is survived by his wife and four children.

WILLIAM "BILL" LUBY ('52) of Phoenix, Arizona, died on August 15, 2014. Luby served in the U.S. Army before attending Colorado Law. He married his wife, Georgia, shortly before returning to school, and the two enjoyed more than 65 years of marriage. He spent his career as an attorney for Travelers Insurance. Luby is survived by his wife, three children, six grandchildren, and 10 great-grandchildren.

JOHN CAMPION MULVIHILL ('53) died on September 17, 2014. Mulvihill dedicated his career to the service of his country in the U.S. Air Force JAG Corps. He was also a passionate outdoorsman. Mulvihill is survived by his wife, brother, six children, 11 grandchildren, and two great-grandchildren.

THE HONORABLE JIM R. CARRIGAN of Boulder, Colorado, passed away on August 15, 2014, at age 84. Judge Carrigan, who grew up in Hallock, Minnesota, attended law school at the University of North Dakota, where he served as editor-in-chief of the law review and graduated first in his class. Judge Carrigan's lifelong love of education led him to teach at the University of Colorado Law School and later serve on the Board of Regents for the University of Colorado. After leaving academia for practice, he became known as one of the state's pre-eminent plaintiffs' attorneys. In 1976, Governor Lamm appointed Judge Carrigan to the Colorado Supreme Court, where he served until being nominated to a seat on the U.S. District Court for the District of Colorado by President Carter in 1979. He is survived by his wife of 58 years, Beverly, six children, and 12 grandchildren. Jim was not an alumnus of Colorado Law, yet his memory will long be recognized through the Carrigan Courtroom, the Carrigan Cup mock trial competition, and a Loan Repayment Assistance Program award that was recently established in his name.

N. BOYD ECKER ('54) passed away in Maryland in October 2014. A graduate and lifelong supporter of Lake Forest Academy, Ecker spent a portion of his career working for Mobil Oil Corporation and practiced in Washington, D.C.

HUBERT "HUB" SAFRAN ('54) passed away in Greenwood Village, Colorado on December 17, 2013. Safran served in the Colorado General Assembly for 10 years beginning in 1965, and thereafter he worked tirelessly as a private attorney, college professor, civil rights activist, husband, and father. Safran is survived by his wife, sister, and four children.

JOHN "JACK" SPRINGER SCHAPER ('55) passed away quietly on December 26, 2014, after a long and valiant fight against cancer. A Boulder native, Schaper practiced law in Colorado until he relocated to Arizona, where he remained an active member of the bar until his retirement in 2004. Schaper, whose practice focused on natural resources and water law and civil appellate litigation, represented Buckeye Irrigation Company for more than 40 years and served as special assistant attorney general in Arizona and special counsel to the city of Phoenix.

FRANK F. SPIECKER ('55), longtime Grand Junction, Colorado, attorney, passed away on September 15, 2014. In 1964, Spiecker became the first elected district attorney for the newly created 21st Judicial District of Colorado. He went on to practice as a prosecutor for more than a quarter century. Spiecker enjoyed swimming, fishing, skiing, and vintage automobiles. In 2008, he moved to the Front Range to be closer to his children and grandchildren. Spiecker is survived by a brother, son, two daughters, and seven grandchildren.

NEIL CALDWELL KING ('56), a land conservation practitioner for nearly 40 years, died in Boulder on December 12, 2014. King's passion for conservation was evidenced during his time as Boulder city attorney, during which King fought to block development near Chautauqua and ushered in a push to secure open space in and around Boulder County. Throughout his career, King was responsible for preserving thousands of acres of Boulder County open space through the purchase of various wilderness areas and historic ranches. King, the son of Colorado Law's longest-serving dean, Edward C. King, after whom the dean's suite is named, grew up in Boulder and was well-known in town, even owning the famed Tulagi's for a period of time in the 1970s. King is survived by his wife of nearly 60 years, Gretchen, their five children, 14 grandchildren, and one great-grandchild.

FORREST GORDON "MIKE" WINNINGHAM ('56) died on December 5, 2014, in Saratoga, California. Following graduation, Winningham established a law practice in San Jose, where he focused on civil law, finding particular enjoyment in handling adoptions. Winningham, a consummate family man, was passionate about backgammon, sports, houseboating, fishing, and history. He is survived by his wife and their four children.

ALAN A. ARMOUR ('58) passed away at his retirement home in Tucson, Arizona, on October 10, 2014. Before attending Colorado Law, Armour served in the U.S. Army during the Korean War. As an attorney, he practiced for 32 years in construction litigation. He preferred to work before juries and had great faith in the innate fairness of ordinary citizens. Armour loved basketball, golf, and his wife of more than 60 years, his two children, and four grandchildren.

JAMES ARTHUR STANDER ('58) of Littleton, Colorado, passed away peacefully on September 20, 2014. A native of western Nebraska, Jim was a successful attorney, avid sportsman, proud veteran, and loving husband, father, and friend. He is survived by his wife, sister, three children, and three grandchildren.

MICHAEL ROLLINS FURBUSH ('59) passed away in Reno, Nevada, on November 28, 2014. Furbush spent the early part of his career practicing law in Denver, focusing on banking. As a partner in the Warren Livestock Company in the 1960s, Furbush negotiated the sale of missile sites to the U.S. Air Force. After relocating to Nevada with his wife, Lee, in the late 1960s, Furbush served as vice president at Valley National Bank where he oversaw the financing of some of the largest commercial properties in the state of Nevada. A devoted grandfather, avid birder and fisherman, and roundup rider for 50 consecutive years, Furbush is survived by his wife, their two children, and two grandchildren.

STANLEY RICHARD MEDSKER ('59), originally of Dodge City, Kansas, died on August 12, 2014, in Denver. After serving in the U.S. Army, Medsker met his wife, Aldah, who inspired him to enter law school. Medsker served as general counsel for the Frontier Refining Company in Denver, and later he co-founded Stop'n Save convenience stores of Colorado. Medsker loved bicycling, skiing, living in Colorado, and above all, his wife, three children, and eight grandchildren.

JAMES "JIM" G. WILLSON, JR. ('59) died peacefully on November 17, 2014. Willson, a Colorado native, practiced municipal finance, first with Tallmadge & Tallmadge Law Firm and then opened the Willson & Lamm Law Firm. Willson was an active member of the Republican Party, served as a legal advisor to the Rocky Mountain Guides Association, and loved the Colorado mountains and the Denver Nuggets. He is survived by his wife of 58 years and their two children, four grandchildren, and three great-grandchildren.

CLIFFORD IWAO ARINAGA ('62) passed away in his native Hawaii on October 3, 2014, following a 13-year battle with Parkinson's disease. He served in the U.S. Army in World War II and was a member of the Hawaii Bar Association for 52 years. Over those years, Arinaga worked for the Hawaii Department of the Attorney General and in private practice. He is survived by his wife, four siblings, and three children.

KENNETH REUBEN NUSS ('62) passed away peacefully on December 15, 2014, in Colorado Springs, Colorado, following a long illness. A veteran of the Korean War, Nuss enjoyed practicing law for over 50 years. He is survived by his wife, two daughters, and six grandchildren.

JERRY EUGENE QUICK ('66) of Little Rock, Arkansas, passed away on February 7, 2014. Quick married his high school sweetheart, June Call, at age 16, and they raised four children together. In addition to practicing law, Quick was involved with the Boy Scouts of America, the Chamber of Commerce, Lions, and Jaycees. After retirement, he wrote a murder mystery book, *The Best of Intentions*. Quick is survived by his wife, brother, children, and grandchildren.

THE HONORABLE JONATHAN HAYS ('68) of Weld County, Colorado, passed away on September 16, 2014. Judge Hays came to Weld County in 1970 as the county's first public defender. He was appointed to the bench in 1973 and advanced to the district court in 1975, where he presided for more than 30 years. Judge Hays was an avid hiker, philanthropist, and actor. In his final years, Judge Hays learned Spanish to allow him to interpret for the growing number of Spanish speakers in the legal system. He is survived by his wife and daughter.

RICHARD J. JACOBS ('72) of Roswell, Georgia, passed away on August 25, 2014, following a lengthy illness. Jacobs's legal career began in Alamosa, Colorado, where he represented the city attorney of Alamosa and served the community. In addition to the practice of law, Jacobs enjoyed an active lifestyle, twice completing the Ride the Rockies bike race. Jacobs relocated to Roswell following his retirement. He is survived by his wife and two sons.

CHRISTINA BEARMAN VON WALD ('76) of Cherry Hills Village, Colorado, died on October 18, 2014. Von Wald practiced for 20 years in the areas of commercial litigation, bankruptcy, and employment law. She retired from Xcel Energy in 1997 and spent the following years providing legal advice to nonprofits and serving on boards and board committees for various charitable organizations in Colorado. She is survived by two brothers, two children, three stepchildren, and three grandchildren.

M. WRAY WITTEN ('79), a professional passionate about training young lawyers, lost his battle with cancer on December 3, 2014. Witten, a water rights attorney and environmentalist, was an active member of the Athens, Georgia, community after relocating there in 2008. Witten worked his way through law school at a natural resources law firm, where he continued to work after graduation, eventually becoming a partner in the firm. In the early 1990s, Witten's passion for water quality and the law took him to Ethiopia, where he worked to establish a rural water supply and assisted with the war-torn country's redevelopment efforts. Witten helped to establish Ethiopia's second school of law at Mekelle University, where he served as the law school's first dean. Witten is survived by his wife, Karen, and their 10 honorary Ethiopian grandchildren.

MARGARET ANNE PENN ('88), a Bismarck, North Dakota, resident, died on December 6, 2014. Penn is survived by her sister and two brothers. Before attending law school, Penn taught for 10 years at a Native American K-12 alternative school. Following graduation, Penn joined Leventhal and Associates in St. Paul, Minnesota, where she practiced Indian Law. Penn was a passionate advocate for battered women, particularly on the reservation.

BRIDGET ANN KLAUBER ('92) passed away at her home in Boulder on August 2, 2014. Klauber was a human rights advocate who dedicated a significant portion of her career to abolishing the death penalty in Colorado. She worked for 13 years as a Colorado state public defender and spent the last four years as a private criminal defense lawyer. She is survived by both parents, three sisters, two daughters, and her partner of 27 years.

TARA SUZANNE O'CONNOR ('97) passed away following her valiant fight against cancer on November 14, 2014. O'Connor, a native of Pennsylvania, practiced as an immigration attorney for Piver Law in Pennsylvania and Arizona, serving her clients with passion and integrity. O'Connor was an active outdoorswoman who loved keeping active, embraced healthy living, and promoted local food consumption. The loves of her life were her family, including her husband, Thomas, and her sons, Liam and Quinn.

CLASS ACTIONS

- 1971** Montgomery & Andrews, a full service law firm with offices in Albuquerque and Santa Fe, announced that **Jack Campbell** ('71) joined the firm as a shareholder. Campbell brings a wealth of experience to the firm, with a focus on real estate, business and commercial matters, including estate planning and tax matters.
- W. Harold "Sonny" Flowers, Jr.** ('71) received the Boulder County Bar Association Award of Merit, which recognizes substantial dedication to the legal process. Flowers is an attorney with Hurth, Sisk & Blakemore in Boulder.
- The California State Bar recognized **Betty Nordwind** ('71) with its 2014 Loren Miller Legal Services Award, acknowledging a demonstrated, long-term commitment to legal services and significant work extending legal services to the poor.
- 1973** Moye White LLP welcomed **David Arkell** ('73) to the firm's Denver office as a partner in the firm's construction and alternative resolution group. During his 35 years of practicing construction law, Arkell has assisted clients in resolving disputes through litigation, arbitration, and mediation and will continue to do so at Moye White.
- 1974** **Bernie Buescher** ('74) resigned his position with the Colorado State Attorney General's Office, where he most recently served as deputy attorney general for state services.
- 1976** **Frederick B. Skillern** ('76) received the 2014 Richard N. Doyle CLE Award of Excellence from the CBA-CLE, in recognition of his dedication and contribution. Skillern is an attorney with Montgomery Little & Soran, PC, where his practice focuses on real estate and related litigation.
- 1977** In January, **John Suthers** ('77) ended his 10-year term as attorney general of Colorado. Appointed by Governor Owens to complete the remainder of Ken Salazar's term in 2005, Suthers was elected to two subsequent terms and is the second-longest serving attorney general in Colorado history.
- 1978** The Colorado Judicial Institute awarded **The Honorable Claude W. Appel** ('78) with the Colorado Judicial Excellence Award of 2014 in recognition and support of his commitment to excellence in Colorado courts. Judge Appel sits in the Third Judicial District of Colorado.
- Two law firms have merged to form Otis, Bedingfield & Peters, LLC. **Michael Stewart** ('78), **Christian Schulte** ('97), and **Jennifer Peters** ('99) of Otis & Peters LLC, joined **Timothy Brynteson** ('91) of Bedingfield LLP.
- 1980** **The Honorable Claudia Jordan** ('80) was recognized by Denver Mayor Michael Hancock for her 20 years of service on the Denver County Court bench. The mayor proclaimed September 30, 2014, "Claudia Jordan Day" following her retirement. Jordan was the first African-American woman to serve on the Colorado bench.
- Sara Page** ('80) has taken a position with Costco Wholesale as corporate counsel in Issaquah, Washington.
- 1981** In 2014, **Jeff Cowman** ('81) and **Kim McCullough** ('81) retired from Ballard Spahr LLP. McCullough joined the firm as a partner in 2009 with more than 25 years of experience representing franchisors. Cowman also joined the firm in 2009 and spent his career as a commercial litigator.
- Partners **Kirk Ingebretsen** ('81) and **Chip Sander** ('82) of Sander, Ingebretsen & Wake, P.C., have joined Shook, Hardy & Bacon L.L.P. Shook's new Denver office includes a complex commercial trial and appellate practice that encompasses many areas of law.
- 1982** After 26 years of service, **Tony Turrini** ('82) retired from the National Wildlife Federation, where he worked as senior counsel.
- Daniel A. Vigil** ('82) retired from the University of Denver in June 2014. Vigil, who has a long-standing connection to Colorado's law schools, most recently worked as an assistant dean and adjunct professor at the Sturm College of Law.
- 1985** Together with Rick Wedgle, **Steve Epstein** ('85) announced the formation of Wedgle Epstein, P.C., which represents clients in all aspects of family law.
- The Aurora City Council named **Michael Hyman** ('85) as city attorney. Hyman has been with the city attorney's office in Aurora for 28 years.
- 1986** **Chris D. Hefty** ('86) announced the opening of his new practice, The Law Office of Chris D. Hefty. Located in Loveland, Colorado, the practice serves clients with bankruptcy, criminal law, and personal injury needs.
- The Honorable Donald S. Quick** ('86) was appointed to the bench in the 17th Judicial District by Governor John Hickenlooper. Most recently, Judge Quick was senior counsel at Beatty & Wozniak, P.C. He served as district attorney for the 17th Judicial District from 2005-2013.
- 1987** **John Carson** ('87) was sworn in as a member of the CU Board of Regents in January. He will serve a six-year term. Carson, who represents the 6th Congressional District, is chief legal and compliance officer for Cherry Creek Mortgage Company in Greenwood Village, Colorado.
- Mining, energy, and infrastructure attorney **Robert D. Comer** ('87), joined the Denver office of Norton Rose Fulbright US LLP as a partner. Comer's practice focuses on regulatory, compliance, permitting, and operating issues in the mining, oil, gas, energy, and related industries.
- Governor John Hickenlooper appointed **The Honorable Frederick Martinez** ('87) as district court judge in the 18th Judicial District. Judge Martinez was previously a member at Hall & Evans, LLC.
- Thomas M. Piccone** ('87) was named to lead the Securities and Exchange Commission's National Exam Program in the Denver regional office. As associate regional director for examinations, he will oversee examinations of broker-dealers and transfer agents as well as investment advisers and investment companies throughout an eight-state region.
- 1988** **Bradford L. Geiger** ('88) has joined the family law practice of Walker Wright & Associates, LLP. Geiger's practice focuses on family law issues.
- Lynne M. Hanson** ('88) joined Moye White LLP as a partner. Hanson has been representing clients in issues involving franchising and distribution regulatory law for more than 20 years, frequently serving as outside general counsel for franchisors.
- Austin Hamre** ('88) has restructured and renamed his firm Hamre, Rodriguez, Ostrander & Dingess, PC. The firm has a civil practice emphasizing water rights, eminent domain, real estate, and commercial litigation.
- Gary Moschetti** ('88) has rejoined Hatch Ray Olsen Sandberg LLC and will continue his practice in real estate, lending and secured transactions, landlord/tenant law, receiverships, business, and commercial transactions and litigation.
- 1991** **Sandra Schubert** ('91) joined Sacramento's Somach Simmons & Dunn, where she will work with the firm's agriculture, air, environmental, and water law clients. Schubert, former counsel to the majority leader of the U.S. Senate, joined the firm after serving as undersecretary to the California Department of Food and Agriculture.

We are proud of our alumni and want to hear about your personal and professional achievements, celebrations, and other important milestones. To appear in Class Actions, please submit your news to lawalum@colorado.edu. If your contact information or communication preferences have changed, you can update them at colorado.edu/law/reconnect.

1992 Lewis Roca Rothgerber LLP has selected **Michael Plachy** ('92) as its litigation practice group leader. Plachy is a trial lawyer who represents companies in civil lawsuits involving significant financial or reputational exposure, including complex commercial litigation and class actions.

1993 The Colorado Medical Society awarded **Elisabeth Arenales** ('93) the Tip of the Spear award, recognizing her creation of the Colorado Commission on Affordable Health Care. Arenales is the health program director for the Colorado Center on Law and Policy.

Greg Perkins ('93) has rejoined with two previous partners to form Wear Travers Perkins LLC in Vail, Colorado. Perkins's practice focuses on representing clients in real estate transactions and matters involving small businesses, homeowners associations, and land use.

Si Se Puede, a law school pipeline mentoring program founded by U.S. District Court Judge Christine Arguello, has tapped **Lorenzo Trujillo** ('93) as its first president of the board of directors. Trujillo, former general counsel for the Hispanic National Bar Association and deputy director of the National Association of Counsel for Children, brings a rich background to the position.

1995 **Michael E. Brewer** ('95), who currently serves as the head of Littler Mendelson's Walnut Creek, California, office, has been named a managing shareholder of the firm's San Francisco office. Brewer represents employers in all aspects of labor and employment law, including class and collective actions that involve alleged wage and hour violations, sexual harassment, discrimination, retaliation, wrongful termination, and employment-related torts.

On July 17, **Christine Mastin** ('95) and her husband Charles welcomed Fikre "Fikki" Wudassie Mastin into their family. The family spent six weeks in Africa last summer finalizing her adoption.

1996 **Cara Lawrence** ('96) welcomed her son, Oliver Arthur Lawrence, into her family. Oliver joins sisters Ingrid and Isla.

Senior Assistant Attorney General **Janet Drake** ('96) has been named president-elect of the Denver Bar Association and will begin her one-year presidency in July. In 2014, Drake received the National Association of Attorneys General "Faculty of the Year" award for her efforts to combat human trafficking.

Margaret Polson ('96) opened a firm specializing in patent, trademark, and copyright law. Polson Intellectual Property Law P.C., is based in Westminster, Colorado.

1998 Polsinelli PC named **Jennifer Evans** ('98) managing shareholder of the Denver office of the Kansas City-based firm. Evans's health care practice focuses on fraud and abuse, Medicare and Medicaid reimbursement issues, and regulatory compliance.

Carrying on Colorado Law's strong tradition of public service, **Arturo Jimenez** ('98) has served on the Denver Public Schools Board of Education as a board member representing District 5 for nearly seven years. The position is an unpaid, elected position, and Jimenez's district comprises a fifth of the city. Jimenez is the senior member of the board and is the board's only Spanish speaker.

Brian R. Leone ('98) opened The Leone Law Firm in Fort Collins, Colorado, in 2014. Leone is a business attorney representing clients throughout Colorado.

1999 **Nicholas Dooher** ('99) joined Davis & Ceriani, P.C.'s real estate and transaction law practice.

2000 **Adam DeVoe** ('00) of Lewis Roca Rothgerber LLP has been appointed chairman of the board of directors for Denver B-Cycle.

Rick Hosley ('00) joined the Denver office of Hogan Lovells as a partner in the litigation practice, bringing over a decade of trial experience with him. Hosley previously served in the U.S. Attorney's Office as chief of the Major Crimes Section.

Vaughan & DeMuro proudly named **Jennifer C. Madsen** ('00) as its newest shareholder. Madsen's practice focuses on employment, insurance bad faith and coverage, and professional liability defense.

Colorado Department of Personnel & Administration Deputy Executive Director **Kara Veitch** ('00) was honored with the City of Denver's esteemed Monte Pascoe Award. The award is presented annually to "a person who has worked tirelessly to improve the community around them, promote international understanding, provide encouragement of others who seek to contribute to the community, fight for justice and equal opportunity for all people and show a willingness to assume responsibility for leadership."

2001 **Matthew D. Pluss** ('01) joined the real estate practice group of Senn Visciano Canges P.C. as a director.



Jack Campbell ('71)



Robert D. Comer ('87)



Sandra Schubert ('91)



Michael Plachy ('92)



Michael E. Brewer ('95)



Baby of Christine Mastin ('95)

CLASS ACTIONS

- 2002** Greenberg Traurig, LLP added **David Poticha** ('02) to its intellectual property and technology practice. Poticha joins the firm from the University of Colorado's Technology Transfer Office on the Anschutz Medical Campus. His practice focuses on biotechnology and biosciences.
- 2003** **Reed Morris** ('03) was named a member of Mallon Lonnquist Morris & Watrous. Morris's practice focuses on commercial litigation.
- David C. St. John-Larkin** ('03) has been promoted to partner at Perkins Coie LLP. St. John-Larkin is a member of the firm's intellectual property practice in the Denver office. His practice emphasizes patent analysis, patent prosecution, and licensing.
- 2004** **Angela D. DeVine** ('04) was named a director of Silver & Deboskey. DeVine's practice focuses on personal injury, probate, and commercial litigation.
- Lewis, Longman, & Walker, P.A., of West Palm Beach, Florida, elected **Tara Duhay** ('04) as its newest shareholder. Duhay's practice includes counseling clients in issues involving land use, development, sustainability, and environmental and administrative permitting issues.
- Caplan and Earnest LLC announced that education law attorney **Kristin Edgar** ('04) has been made a member of the firm. Edgar specializes in representing school districts, health services districts, and county hospitals.
- Jon Lehmann** ('04) married Sarah Dixon on May 10, 2014. Lehmann is director of government and regulatory affairs for Comcast Cable Corporation.
- 2005** In October 2014, **Coulter Bump** ('05) welcomed her new daughter, Witten Carter Fell, into her family. Bump is an associate at Caplan and Earnest LLC, and her practice focuses on providing legal services to school districts.
- Frank Crociata** ('05) was named staff attorney for the New Mexico Taxation and Revenue Department.
- Dinsmore & Shohl LLP welcomed **Kwali Farbes** ('05) as of counsel. Farbes joins the firm's finance department.
- The nonprofit Colorado Consumer Health Initiative named **Adela Flores-Brennan** ('05) as its executive director. The initiative is a statewide, consumer-focused nonprofit organization working to achieve barrier-free access to quality and affordable health care for all Coloradans.
- Amanda Howe** ('05) accepted a position as real estate counsel for DaVita Healthcare Partners in Denver.
- Sheridan Ross P.C. named **Sarah Schneider** ('05) as a shareholder. Schneider's practice focuses on trademark and copyright, and she assists clients with issues involving prosecution, policing, licensing, and transactions.
- 2006** **Nicki Cerasoli** ('06) has joined Izbiky & Associates as an associate. The firm's practice focuses on the purchase and sale of businesses, the establishment and maintenance of corporations and LLCs, the drafting and review of contracts, the review of leases, and trademark registrations.
- Nicholas Kant** ('06), deputy attorney general for the state of New Jersey, Affirmative Civil Enforcement Practice Group, successfully represented the state of New Jersey in a number of cases in 2014. His victories included securing \$177,000 in restitution for defrauded homeowners and in securing \$173,000 for law enforcement agencies that purchased defective bulletproof vests.
- Lisa Neal-Graves** ('06) has taken a position with Intel as director of technology insights in Portland, Oregon.
- Faegre Baker Daniels LLP promoted **Matt Stamski** ('06) to partner. Stamski's practice focuses on general corporate matters, including mergers and acquisitions, private equity transactions, venture financings, securities offerings, commercial contracts, and counseling emerging companies.
- 2007** **Josh Anderson** ('07) of Dietze and Davis, P.C., was selected for the Boulder County Bar Association's 2014 Outstanding Young Attorney of the Year Award.
- The Edgewater Collective appointed **Sarah B. Clark** ('07) to serve on its board of directors. The Edgewater Collective leads collective impact efforts concerning education in Edgewater, Colorado. Clark currently practices with Brownstein Hyatt Farber Schreck, LLP.
- DCP Midstream, LP welcomed **George Green** ('07) as senior counsel for litigation, managing the company's litigation matters.
- Thomas Kranz** ('07) co-founded the Boulder firm of Jung & Kranz, P.C., where he will continue representing clients in a variety of practice areas, including construction, personal injury, civil litigation, real estate, business, and employment law.
- 2008** **Jennifer DiLalla** ('08) was named a shareholder at Moses, Wittemyer, Harrison and Woodruff, P.C. DiLalla, who has been with the firm since 2011, represents clients in a wide range of water law issues.
- Mary Lynn Macsalka** ('08) relocated to Anchorage, Alaska, where she joined the state of Alaska Department of Law as an assistant attorney general. Her practice includes rural energy projects, municipal issues, and campaign finance law. In April 2014, Macsalka married Craig Skinner, Pharm.D.
- Holland & Hart LLP welcomed **Jill Van Noord** ('08) to its environment, energy, and natural resource practice.
- 2009** **Jeremy Durham** ('09) became development program manager for the Denver Housing Authority in August 2014.
- Elisabeth Mankamyer** ('09) accepted a position with the real estate litigation firm Alderman Bernstein.
- 2010** On July 5, 2014, **Chris Achatz** ('10) married Erica Siepman at the Inverness Hotel in Denver. Achatz is legal counsel at IHS.
- Husch Blackwell LLP welcomed associate **Marshall A. Custer** ('10) to its Denver office. Custer is a member of the firm's securities and corporate governance group and counsels high-tech startups on formation, financing, intellectual property, and governance matters.
- Robert Gregory** ('10) joined West Brown Huntley Hunter Teodoru PC in Breckenridge, Colorado. Gregory's practice focuses on criminal defense and a broad spectrum of civil litigation and transactional matters.
- Jonathan Haskell** ('10) joined Wade Ash Woods Hill & Farley, P.C., as an estate planning associate.
- Kerry LeMonte** ('10) gave birth to her son, Andrew "Drew" LeMonte, on October 28. LeMonte is an associate in Brownstein Hyatt Farber Schreck, LLP's litigation department, where she represents clients in disputes involving intellectual property, labor and employment, health care, and other business agreements.
- Trips for Kids Denver/Boulder, which provides mountain bike outings and environmental education to underserved youth, named **Avi Loewenstein** ('10) as its newest board member. Loewenstein is an associate at Brownstein Hyatt Farber Schreck, LLP.

The Rocky Mountain Immigrant Advocacy Network honored **Jorge Loweree** ('10), senior counsel with the Office of Congressman Jared Polis, with its Immigration Liberty Award.

Pamela Maass ('10) joined the Rocky Mountain Victim Law Center as its legal director. The center provides free legal assistance to victims of violent crime.

Jamal Trager ('10) accepted a position with Travelers as an insurance underwriter specializing in management liability.

2011 Lathrop & Gage LLP welcomed **Alison Foster** ('11) as an associate in the firm's energy practice.

John C. Hoelle ('11) announced the opening of his law and mediation practice in Boulder. Fabish | Hoelle LLC represents clients in matters concerning divorce, custody, relationship agreements, and business disputes. The practice also provides mediation and conflict-resolution services.

Jodie Hoke ('11), manager of the Clinical Educations Program at Colorado Law, welcomed her second son, Henry Gilbert Hoke, on April 1, 2014. Henry joins big brother Benjy.

The Envision Healthcare Corporation welcomed **Amanda Matlock** ('11) as corporate counsel.

Julie Nania ('11) is water director with High Country Conservation Advocates in Crested Butte, Colorado.

Katy O'Brien ('11) joined Greenberg Traurig, LLP, as an associate focusing on commercial real estate transactions.

The Hispanic National Bar Association named the Latinas First Foundation its Pro Bono Corporation of the Year. The foundation provides networking, support, and nontraditional scholarships to Latinas. It was co-founded by **Meshach Rhoades** ('11) of Greenberg Traurig, LLP.

Temkin Wielga & Hardt LLP welcomed **Michael Toll** ('11) as an associate. The firm specializes in environmental and natural resource law and complex civil litigation.

On July 5, 2014, **Bryan McCutcheon** ('11) and **Heather Strack** ('12) were married. Strack practices family law at The Harris Law Firm P.C., and McCutcheon is an associate in Gibson Dunn's corporate transactions practice group.

2012 **Carolyn Black** ('12) joined Minor & Brown, PC as an associate. Her practice areas include business sales and acquisitions and real estate law.

Jeffrey Graves ('12) took a position with the Adams County District Attorney's office.

Brownstein Hyatt Farber Schreck, LLP welcomed **Shane C. Griffin** ('12) as a new associate in its real estate department. Griffin's practice focuses on representing clients in the acquisition, development, financing, leasing, and disposition of commercial properties.

Sherman & Howard L.L.C. welcomed **Beth Ann Lennon** ('12) as an associate in its employment and labor law practice.

Rachel Rice ('12) accepted a position as an associate with Sheridan Ross P.C. The firm specializes in intellectual property law.

Mark Stockwell ('12), associate at Brownstein Hyatt Farber Schreck, LLP, has been appointed to serve on the board of directors for the Youth Opportunity Foundation. The foundation provides mentoring, educational opportunities, and life experiences for at-risk youth.

Sadie Sullivan ('12) joined Husch Blackwell LLP in Denver as an associate in their healthcare, life sciences and pharmaceuticals industry team. Sullivan advises healthcare providers and associations in fraud and abuse matters, Medicare/Medicaid reimbursement, health facility and professional licensing, regulatory compliance, business planning and commercial transactions, and government relations.

2013 Lewis Roca Rothgerber LLP welcomed **Dietrick Hoefner** ('13) as an associate in its government and regulatory practice.

Shira Cooks ('13) joined Davis Graham & Stubbs LLP's finance and acquisitions group as an associate.

Kilpatrick Townsend & Stockton LLP is proud to announce **Adam Gianola PhD** ('13) as its newest patent associate. Gianola is a registered patent attorney, and his practice focuses on patent prosecution and counseling.

Elizabeth Joyce ('13) joined Lyons Gaddis Kahn Hall Jeffers Dworak & Grant PC as an associate in the water practice group.

Lauren E. Walker ('13) joined Kutak Rock LLP as an associate, focusing on commercial real estate and corporate transactions.

Emily Wasserman ('13) joined Davis Graham & Stubbs as an associate in the trial department.



David C. St. John-Larkin ('03)



Baby of Coulter Bump ('05)



Matt Stamski ('06)



Baby of Kerry LeMonte ('10)

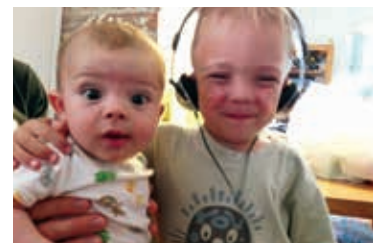

Children of Jodie Hoke ('11)



Heather Strack ('12)
and Bryan McCutcheon ('11)

THE PLATE IS HOT. HAVE A GOOD TIME.

Former Colorado Supreme Court Justice Alex J. Martinez ('76)

Forty-one years ago, I was at a gathering, a gathering that did not involve law school deans, firms, judges, or elected officials. It was just a small party at a professor's house welcoming minority students, probably four or five years after the era when there were not any significant numbers of diverse students in any of our law schools at all. And by "significant," I do not mean "significant," I mean more than one or two.

Standing around a keg of beer, I met a few people who became lifelong friends. Over a period of four decades we helped each other struggle through law school, fretted about jobs, raised families, considered options, prepared for interviews, resolved problems, affected peoples' lives, sought help, and celebrated successes.

Beginning with that small group of people, my professional friends, the people who support me and inspire me, have expanded enormously in this profession—and I say this most sincerely—of honorable men and women. I hope that all alumni will develop such rewarding relationships; so many are willing to make themselves available for mentoring, guidance, and friendship.

The people around the keg in 1973 were mostly fresh out of college, children of the Sixties. As a young boy in northeast Denver, I was inspired by the courage of the freedom fighters, the youthful optimism of the Kennedys, the promise of the Civil Rights Movement, the satisfaction of having Thurgood Marshall on the U.S. Supreme Court, and the dramatic shift from what sometimes seemed like shame, to ethnic and racial pride. The assassinations of the Kennedys and Martin Luther King, Jr., Watts, Vietnam, the Chicago Seven, and the Nixon tapes were some of the images of hope and naïveté crumbling to the harsh realities of a more complex world.

I went to law school because my father was held in mental institutions for much of his life. I went to law school because my mother fought Social Security and Veterans Administrations for the survival of her family. I went to law school because cops held me and my friend on the ground at gunpoint.

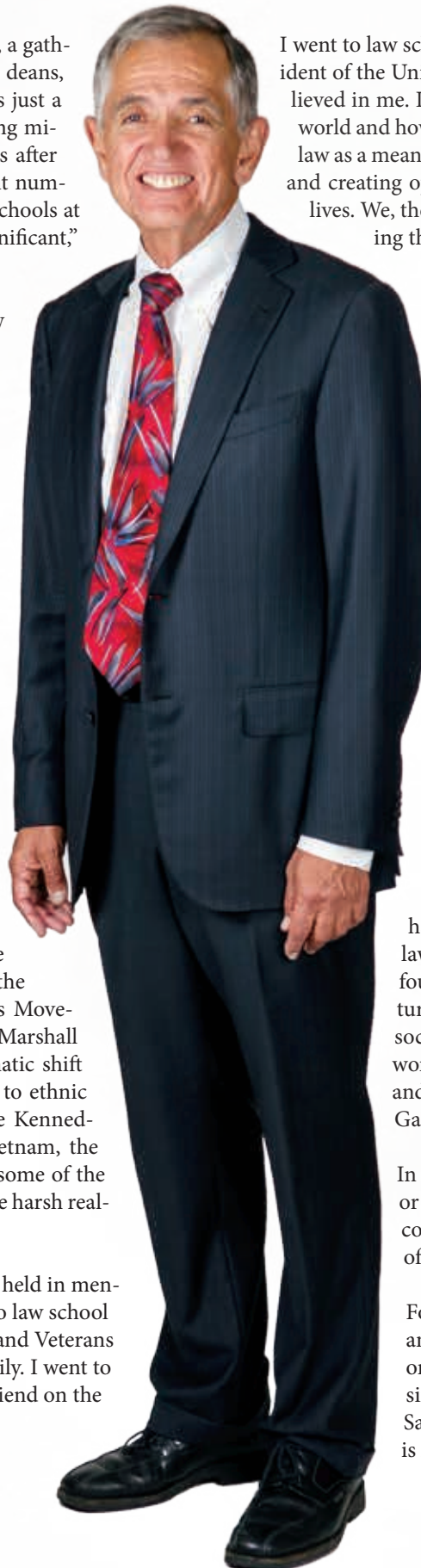

I went to law school because Father Moynihan told me I could be president of the United States. I went to law school because my mother believed in me. I went to law school because I had a glimpse of another world and how things could be. I went to law school because I saw the law as a means of correcting inequities, defending rights and liberties, and creating opportunities for people to lead healthy and productive lives. We, the people around the keg, did not imagine how challenging that would be.

I had some great opportunities. I defended desperate people, listened to the troubles and struggles of peoples' lives, tried to find and reach elusive justice, endeavored to move institutions at least a little bit and make them more responsive to the needs of the people, because the law is meant to work for the people, not against them. I am enjoying a wonderful career. The people around the keg did not imagine that one day we would own the inequities, the status quo, the system, and eventually leave it to another generation, in all its glory and with all its faults.

Today, we the lawyers and judges and professors, we need the next generation to continue to address inequities and improve the societal organizations that are intended to enhance lives and make opportunities available. The law is the very fabric of our social structure, and there are a lot of careers in the law and elsewhere which will benefit from the analytic process of reason and judgment that is our duty to learn, to teach, and to advance.

It is no coincidence that many of the people who have had tremendous impact on the world around them were lawyers. To provoke thought and reflection, I mention four who have thought deeply about the history and structure of their nations, attempted to change the nature of societies and to right inequities, who have impacted the world and inspired millions, and not without controversy and violence. Lawyers all, and trial lawyers at that: Lincoln, Gandhi, Mandela, Fidel Castro.

In practice, lawyers may work to improve some institution, or in some other way apply what we have learned. Bring compassion, grace, intelligence, and learning to all facets of the profession.

For a final word, a closing wish, I turn not to the words and wisdom of one of the famous people I have mentioned or to whom I have alluded, but instead to the words of a simple waiter who 35 years ago in the ominously named Satire Lounge on East Colfax was fond of saying: The plate is hot. Have a good time.



ESTABLISH YOUR LEGACY AT COLORADO LAW

With funding by the Colorado General Assembly down to four percent of the total funding of the CU-Boulder campus, it is up to us who benefitted so greatly from the education we received at the law school to step up and provide the resources to keep Colorado Law the top tier school it is now."

Rob ('75) & Patti Beebe

For more information on charitable gift annuities or other ways to include Colorado Law in your estate planning, please contact:

Ellen Goldberg

303.735.3689

ellen.goldberg@colorado.edu

University of Colorado Law School
2450 Kittredge Loop Road
401 UCB
Boulder, CO 80309

Nonprofit
U.S. Postage Paid
Boulder, CO
Permit No. 156

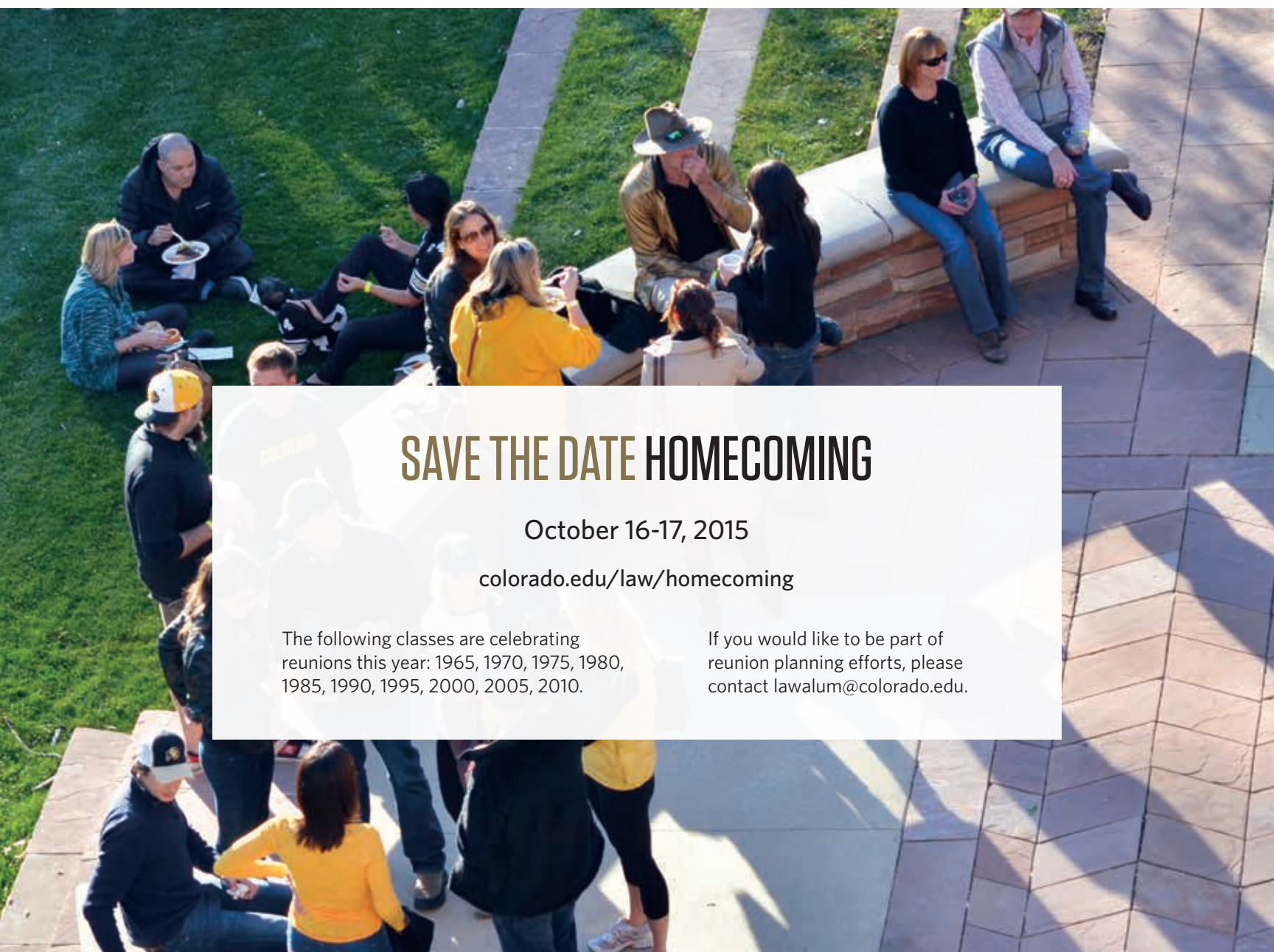

SAVE THE DATE HOMECOMING

October 16-17, 2015

colorado.edu/law/homecoming

The following classes are celebrating reunions this year: 1965, 1970, 1975, 1980, 1985, 1990, 1995, 2000, 2005, 2010.

If you would like to be part of reunion planning efforts, please contact lawalum@colorado.edu.